

# FURUNO

## OPERATOR'S MANUAL

### MARINE RADAR

#### MODEL FAR/FR-2805 Series

<u>Radar</u>	<u>ARPA</u>	<u>Basic Spec.</u>
<input type="checkbox"/> FR-2815	<input type="checkbox"/> FAR-2815	X-band, 12 kW, TR up
<input type="checkbox"/> FR-2825	<input type="checkbox"/> FAR-2825	X-band, 25 kW, TR up
<input type="checkbox"/> FR-2855	<input type="checkbox"/> FAR-2855	X-band, 50 kW, TR up
<input type="checkbox"/> FR-2825W	<input type="checkbox"/> FAR-2825W	X-band, 25 kW, TR down
<input type="checkbox"/> FR-2855W	<input type="checkbox"/> FAR-2855W	X-band, 50 kW, TR down
<input type="checkbox"/> FR-2835S	<input type="checkbox"/> FAR-2835S	S-band, 30 kW, TR up
<input type="checkbox"/> FR-2835SW	<input type="checkbox"/> FAR-2835SW	S-band, 30 kW, TR down
<input type="checkbox"/> FR-2865SW	<input type="checkbox"/> FAR-2865SW	S-band, 60 kW, TR down
	<input type="checkbox"/> FA-2805	Add-on ARPA



**FURUNO ELECTRIC CO., LTD.**  
NISHINOMIYA, JAPAN

© **FURUNO ELECTRIC CO., LTD.**

9-52, Ashihara-cho,  
Nishinomiya, Japan

Telephone: 0798-65-2111  
Telefax: 0798-65-4200

•Your Local Agent/Dealer

All rights reserved. Printed in Japan

FIRST EDITION : AUG. 1995  
X2 : FEB. 22, 2002

(YOSH) PUB. No. OME-34040  
FAR/FR-2805 SERIES



\* 00080722300 \*



\* OME34040X20 \*



# SAFETY INSTRUCTIONS



## DANGER



**Before turning on the radar, make sure that there is no one near the scanner unit.**

Serious injury or even death may result if a rotating antenna strikes someone standing nearby.



## WARNING

### Radio Frequency Radiation Hazard

The radar antenna emits electromagnetic radio frequency (RF) energy which can be harmful, particularly to your eyes. Never look directly into the antenna aperture from a close distance while the radar is in operation or expose yourself to the transmitting antenna at a close distance.

Model	Radiator type	Distance to 100 W/m <sup>2</sup> point	Distance to 10 W/m <sup>2</sup> point	RF power density on antenna aperture
FR-2815 (X-band, 12 kW)	XN12AF (4')	Worst case 0.25 m*	Worst case 2.3 m*	11.0 W/m <sup>2</sup>
	XN20AF (6.5')			9.6 W/m <sup>2</sup>
	XN24AF (8')			9.6 W/m <sup>2</sup>
FR-2825/2825W (X-band, 25 kW)	XN12AF (4')	Worst case 0.6 m*	Worst case 3.25 m*	29.0 W/m <sup>2</sup>
	XN20AF (6.5')			23.8 W/m <sup>2</sup>
	XN24AF (8')			23.8 W/m <sup>2</sup>
FR-2855/2855W X-band,50KW	XN3A (6.5')	Nil	2.0m	76.0 W/m <sup>2</sup>
	XN4A (8')	Nil	1.9m	64.0W/m <sup>2</sup>
	XN5A (10')	Nil	1.8m	50.0W/m <sup>2</sup>
FR-2835S/2835SW (S-band, 30 kW)	SN30AF (10')	Nil	1.06 m	20.0 W/m <sup>2</sup>
	SN36AF (12')	Nil	0.5 m	16.0 W/m <sup>2</sup>
FR-2865SW (S-band, 60kW)	SN30AF (10')	Nil	1.2 m	46.0 W/m <sup>2</sup>
	SN36AF (12')	Nil	1.0 m	40.0 W/m <sup>2</sup>

\*UK DRA measured on FR-2815/2825 with NARDA 8616. Other values by FURUNO.

**⚠ WARNING**



**ELECTRICAL SHOCK HAZARD**  
**Do not open the equipment.**

Only qualified personnel should work inside the equipment.



**Turn off the radar power switch before servicing the scanner unit. Post a warning sign near the switch indicating it should not be turned on while the scanner unit is being serviced.**

Prevent the potential risk of being struck by the rotating scanner and exposure to RF radiation hazard.



**Wear a safety belt and hard hat when working on the scanner unit.**

Serious injury or death can result if someone falls from the radar scanner mast.

**Do not disassemble or modify the equipment.**

Fire, electrical shock or serious injury can result.

**Turn off the power immediately if water leaks into the equipment or the equipment is emitting smoke or fire.**

Continued use of the equipment can cause fire or electrical shock.

**⚠ WARNING**

**Do not place liquid-filled containers on the top of the equipment.**

Fire or electrical shock can result if a liquid spills into the equipment.

**Do not operate the equipment with wet hands.**

Electrical shock can result.

**Keep heater away from equipment.**

Heat can alter equipment shape and melt the power cord, which can cause fire or electrical shock.

**⚠ CAUTION**

**Do not use the equipment for other than its intended purpose.**

Use of the equipment as a stepping stool, for example, can result in personal injury or equipment damage.

**No one navigation device should ever be solely relied upon for the navigation of a vessel.**

Always confirm position against all available aids to navigation, for safety of vessel and crew.

# TABLE OF CONTENTS

---

## INTRODUCTION

A Word to the Owner of FURUNO Radar .....	v
About This Manual .....	vi
Features .....	vii
Specifications .....	ix
SYSTEM CONFIGURATION .....	xii

## 1. OPERATION

1.1 Turning on the Power .....	1-1
1.2 Transmitter ON .....	1-1
1.3 Controls .....	1-2
1.4 CRT Brilliance .....	1-6
1.5 Tuning the Receiver .....	1-6
1.6 On-screen Legends and Markers .....	1-7
1.7 Degaussing the CRT Screen .....	1-8
1.8 Initializing the Gyro Readout .....	1-9
1.9 Presentation Modes .....	1-9
1.10 Selecting the Range Scale .....	1-12
1.11 Selecting the Pulsewidth .....	1-12
1.12 Adjusting the Sensitivity .....	1-14
1.13 Suppressing Sea Clutter .....	1-14
1.14 Suppressing Precipitation Clutter .....	1-15
1.15 Interference Rejector .....	1-15
1.16 Measuring the Range .....	1-16
1.17 Measuring the Bearing .....	1-16
1.18 Collision Assessment by Offset EBL .....	1-17
1.19 Measuring Range and Bearing Between Two Targets .....	1-18
1.20 Setting a Guard Zone (Guard Alarm) .....	1-18
1.21 Off-Centering .....	1-19
1.22 Echo Stretch .....	1-20
1.23 Echo Averaging .....	1-21
1.24 Electronic Plotting Aid (EPA) .....	1-22
1.25 Target Trails (Echo Trails) .....	1-24
1.26 Parallel Index Lines .....	1-26
1.27 Anchor Watch .....	1-28
1.28 Origin Mark .....	1-29
1.29 Zoom .....	1-30
1.30 Markers .....	1-30
1.31 Menu Keys .....	1-31
1.32 RADAR 1 and 2 Menu Settings .....	1-32
1.33 Function Keys .....	1-33
1.34 EPA Menu .....	1-39
1.35 NAV INFORMATION Menu and Navigation Data Display .....	1-40
1.36 Radar Map .....	1-42
1.37 Suppressing Second-trace Echoes .....	1-43
1.38 Adjusting Relative Brilliance Levels of Screen Data .....	1-44

1.39	Set and Drift (Set and Rate)	1-44
1.40	Display of Ancillary Information	1-45
1.41	Alarms	1-46

## 2. OPERATION OF ARPA

2.1	General	2-1
2.2	Keys Used for ARPA	2-1
2.3	ARPA Menu Operation	2-2
2.4	Start-up Procedure	2-3
2.5	Automatic Acquisition	2-4
2.6	Manual Acquisition	2-7
2.7	Changing Plot Symbol Size	2-7
2.8	Adjusting Brilliance of Plot Marks	2-10
2.9	Displaying Target Data	2-10
2.10	Mode and Length of Vectors	2-11
2.11	Past Position Display	2-11
2.12	Setting CPA/TCPA Alarm Ranges	2-12
2.13	Setting a Guard Zone	2-13
2.14	Operational Warnings	2-14
2.15	Trial Maneuver	2-15
2.16	ARPA Track Test	2-17
2.17	Criteria for Selecting Targets for Tracking	2-18
2.18	Factors Affecting ARPA Functions	2-19

## 3. RADAR OBSERVATION

3.1	General	3-1
3.2	False Echoes	3-2
3.3	SART (Search and Rescue Transponder)	3-3
3.4	RACON (Radar Beacon)	3-5

## 4. MAINTENANCE

4.1	Periodic Maintenance Schedule	4-1
4.2	Life Expectancy of Major Parts	4-2

## 5. TROUBLESHOOTING

5.1	Easy Troubleshooting	5-1
5.2	Advanced-level Troubleshooting	5-2
5.3	Diagnostic Test	5-5

## APPENDIX

A.1	Performance Monitor	A-1
A.2	For Fishing Vessel	A-2
A.3	Navigation Data (IEC 61162-1 Edition 1 and Edition 2)	A-3
A.4	Sentence Description	A-7

## MENU TREE ..... MN-1

### Declaration of conformity to type

### Declaration of Conformity (FR/FAR-2855, FR/FAR-2855W, FR/FAR-2865SW)

# INTRODUCTION

---

## A Word to the Owner of FURUNO Radar

Thank you for purchasing this FURUNO radar and/or ARPA. We are confident you will discover why FURUNO has become synonymous with quality and reliability.

Dedicated in the design and manufacture of marine electronics equipment for 50 years, FURUNO Electric Company has gained an unrivaled reputation as a world leader in the industry. This is the result of our technical excellence as well as our worldwide distribution and service network.

Please carefully read and follow the safety information and operating and maintenance instructions set forth in this manual before attempting to operate the equipment and conduct any maintenance. Your radar set will perform to the utmost of its ability only if it is operated and maintained in accordance with the correct procedures.

### FR-2805 Series

The FR-2805 Series are available in the following two types:

#### Regular type and IMO type

The Regular type is for fishing boats and pleasure boats where some more functions are provided in addition to the functions of IMO type.

**Note:** You can easily recognize which type your radar/ARPA is by looking at the range scale provided.

The FURUNO FR-2805 Series of radars are designed to meet the exacting requirements of international and national standards and regulations including:

- IMO MSC-64 (67) Annex 4: Performance Standards for Radar Equipment
- IMO A.477 (XII): Performance Standards for Radar Equipment
- A. 694 (17): General requirements for shipborne radio equipment forming part of the global maritime distress and safety system (GMDSS) and for electronic navigation aids
- IEC 60936-1: Shipborne Radar Operational and Performance Requirements
- IEC 60936-2: Radar for HSC
- IEC 60945: Marine Navigational Equipment General Requirements

### FAR-2805 Series ARPA

There are also Regular type and IMO type as in the FR-2805-I series radars. The IMO type ARPA complies with the following (Regular type also complies with but includes more additional functions convenient for practical uses in fishing):

- IMO Resolution A.823 (19): Performance standards for Automatic Radar Plotting Aids
- A. 694 (17): General requirements for shipborne radio equipment forming part of the global maritime distress and safety system (GMDSS) and for electronic navigation aids
- Results of NAV 40/WP.3/Add. I which is to be met for new building on or after January 1, 1997
- IEC 60945:1996-11: Marine Navigational Equipment General Requirements
- Us Navigation safety regulations, Labeling requirement in § 164.38(d)(1) of CFR33

**"This device was designed and manufactured to comply with the International Maritime Organization (IMO) Performance Standards for Automatic Radar Plotting Aids (ARPA)."**



If your ship is 10,000 or more gross tons and scheduled to operate in the navigable waters of the United States, make sure the above label is attached on the ARPA. Otherwise please make one yourself by typing and gluing overleaf with the transparent seal.

### **Precautions on high speed craft**

- Assume your ship is making 40 kt and a target ship is approaching at 40 kt right toward you. Then the relative speed is 80 kt. With the antenna revolving at 42 rpm, the target blip appears jumping to a new location 59 m nearer. This jump corresponds to 23 mm on the 360 mm display using the 0.25 nm range scale. On such a short range you may lose the track of target in the midst of sea clutter, random noise or other targets. Use one step larger range scale.
- ARPA can fail to track a target when the relative speed exceeds 100 kt.

## **About This Manual**

This manual is designed to provide information on operation and maintenance of the FR-2805 series radars as well as fault diagnosis and troubleshooting procedures which may be performed by suitably qualified personnel on board.

In producing this manual, we tried to provide as "user friendly" an operation guide as possible to the many functions of this sophisticated equipment. We would appreciate feedback from you about this manual. Your comments and suggestions would be valuable inputs for future improvement.

### **Categorization by specification**

See the table on the next page.



Item	IMO-type	R-type
Range Scales	0.125, 0.25, 0.5, 0.75, 1.5, 3, 6, 12, 16, 24, 48, 96 nm	FR-2805 and FAR-2805 0.125, 0.25, 0.5, 0.75, 1.5, 3, 6, 12, 24, 48, 72nm  Other models: 0.125, 0.25, 0.5, 0.75, 1.5, 3, 6, 12, 16, 24, 32, 48, (72) 120 nm
Guard Zone	IRange depth fixed to 0.5 nm with both outer and inner limits settable between 3 and 6 nm.	Inward (CZ) or outward (Anchor) guard alarm selectable.  Outer and inner limits can be set at any distance from own ship.  ARPA guard ring: Outer limit: 0.7-32 nm Width of ring: 0.5 nm Sector angle: 1-360°
Off-centering	Up to 75% of range in use in any direction	Up to 100% of range in use in any direction
Anchor Watch	Available in stand-by only	Available in either stand-by or transmit status
Own Ship Mark	Standard mark	Displayed when Anchor Watch is activated. (Entry of ship data required.)
x2 Zoom	No	Yes
Stern Marker	No	Yes

## Features

The new FR-2805 series of radar and the FAR-2805 series of ARPAs are the results of combination of the FURUNO's many years of experience in the marine field and the advanced computer technology. The FR-2805 series and FAR-2805 series are designed to fully meet the exacting rules of the International Maritime Organization (IMO) for installations on all classes of vessels.

The display unit employs a 28" diagonal high-resolution green-phosphor CRT. It provides an effective radar picture of 360 mm diameter leaving sufficient space for on-screen alphanumeric data.

Target detection is enhanced by the sophisticated signal processing technique such as multi-level quantization (MLQ), echo stretch, echo average, and a built-in radar interference rejector. Audible and visual guard zone alarms are provided as standard. Other ship's movement is assessed by trails of target echoes or by electronic plotting. The FAR-2805 series ARPA further provides target assessment by historical plots, vectors and target data table.

On-screen data readouts include CPA, TCPA, range, bearing, speed/course of own ship and up to 3 targets. The ARPA functions include automatic acquisition of up to 20 targets, or manual acquisition of 40 targets. In addition, the ARPA features display of a traffic lane, buoys, dangerous points, and other important reference points.

## General features

- Daylight-bright high-resolution display
- 28" diagonal CRT presents radar picture of 360 mm effective diameter with alphanumeric data area around it
- User friendly operation by combination of tactile backlit touchpads, a trackball and rotary controls
- Audio-visual alert for targets in guard zone
- Echo trail to assess targets' speed and course by simulated afterglow
- Electronic plotting of up to 10 targets in different symbols (This function is disabled when ARPA is activated.)
- Electronic parallel index lines
- Interswitch (optional) built in radar or ARPA display unit
- Enhanced visual target detection by Echo Average, Echo Stretch, Interference Rejector, and multi-level quantization
- Stylish display
- Choice of 10, 25 or 50 kW output for X-band; 30 kW output for S-band, either in the transceiver aloft (gearbox) or RF down (transceiver in bridge)
- Exclusive FURUNO MIC low noise receiver

## ARPA features

- Acquires up to 20 targets automatically plus up to 20 targets manually, or all 40 targets manually
- Movement of tracked targets shown by true or relative vectors. (Vector length 1 to 99 min. selected in 1 min. steps.)
- Setting of nav lines, buoy marks and other symbols to enhance navigation safety
- On-screen digital readouts of range, bearing, course, speed, CPA (Closest Point of Approach), TCPA (Time to CPA), BCR (Bow Crossing Range) and BCT (Bow Crossing Time) of 2 targets out of all tracked targets.
- Audible and visual alarms against threatening targets coming into operator-selected CPA/TCPA limits, lost targets, targets, two guard rings, visual alarm against system failure and target full situation

# Specifications

## ANTENNA RADIATORS

### 1. Type

Slotted waveguide array

### 2. Beamwidth and sidelobe attenuation

Band	X-band					S-band	
	XN12AF	XN3	XN20AF (XN3A)	XN24AF (XN4A)	XN5A	SN36AF	SN30AF
Radiator type							
Beamwidth (Hor.)	1.8°	1.23°	1.23°	0.95°	0.75°	2.1°	2.5°
Beamwidth (Ver.)	20°	25°	20°	20°	20°	25°	25°
Sidelobe att within ±10°	28 dB	24 dB	28 dB	28 dB	26 dB	25 dB	24 dB
Sidelobe att outside ±10°	32 dB	30 dB	32 dB	32 dB	30 dB	30 dB	30 dB

\* 10 ft radiator SN30AF available for NON-SOLAS ship. (FAR-2835S HSC is available for SOLAS ship.)

### 3. Polarization

Horizontal

### 4. Rotation

FR/FAR-2815/2825: 24/42 rpm  
 FR/FAR-2825W/2855W,  
 FR/FAR-2835SW/2865SW: 21 rpm (50 Hz),  
 26 rpm (60 Hz)  
 FR/FAR-2835S: 21 rpm (50 Hz),  
 26 rpm (60 Hz),  
 45 rpm (for HSC)  
 FR/FAR-2855: 16 rpm (50 Hz),  
 20 rpm (60 Hz or DC)

## RF TRANSCEIVER

### 1. Frequency

X-band: 9410 MHz ±30 MHz  
 9415 MHz ±30 MHz(50kW)  
 S-band: 3050 MHz ±30 MHz

### 2. Output power

FR/FAR-2815: 12 kW  
 FR/FAR-2825/2825W: 25 kW  
 FR/FAR-2855-I/2855W: 50 kW  
 FR/FAR-2835S-I/2835SW: 30 kW  
 FR/FAR-2865SW: 60 kW

### 3. Pulselength/PRF

FR/FAR-2815/2825

Range(nm)	Pulselength(μs)	PRR(Hz)
0.125, 0.25	0.07	2200
0.5, 0.75	0.07/0.15	2200
1.5	Two from 0.07, 0.15, 0.3	2200/1000
3	Two from 0.15, 0.3, 0.5	2200/1000
6	Two from 0.3, 0.5, 1.2	1000/600
12, 24	Two from 0.5, 1.2	1000/600
48, 96	1.2	600 (48 nm)/500 (96 nm)

FR/FAR-2825W, 2855, 2855W, 2835S, 2835SW, 2865SW:

Range (nm)	Pulselength (μs)	PRR (Hz)
0.125, 0.25, 0.5	0.08	2200
0.75, 1.5	0.08/0.3*	2200
3	Two from 0.08, 0.3*, 0.6	2200/1100
6	Two from 0.08, 0.3*, 0.6	2200/1100
12, 24	0.6, 1.2	1000/600
48, 96	1.2	600/500

\*: In case of FR-2855, FR-2855W, FR-2865SW 0.3 is replaced with 0.2.0

### 4. I.F.

60 MHz, Logarithmic  
 S1-M1: 28 MHz  
 M2-Lpulse: 3 MHz

### 5. Duplexer

Ferrite circulator with diode limiter for FR/FAR-2815/2825/2835S/2835sw  
 Ferrite circulator with TR limiter for FR-2825W/2855/2855W/2865SW

### 6. Noise figure

FR/FAR-2815/2825/2825W/2855/2855W/  
 2835S: 6 dB  
 FR/FAR-2835SW: 4 dB  
 FR/FAR-2865SW: 4.5 dB

## RADAR DISPLAY

### 1. Picture tube

28" color CRT, Effective radar diameter 360 mm  
 IMO type: Yellow or green echoes in 16 levels  
 R-type: Yellow or green echoes in 16 levels or 3 colors depending on echo strengths  
 Different color for VRM, range rings, alarms, etc.  
 Raster scan at 32.25 kHz horizontal, 60 Hz vertical. Number of scanning lines 1024, interlaced.

### 2. Minimum range and discription

35 m

### 3. Range scales (nm)

IMO type:  
 0.125 (.025), 0.25 (0.05), 0.5 (0.1), 0.75 (0.25), 1.5 (0.25), 3 (0.5), 6 (1), 12 (2), 24 (4), 48 (8), 96 (16)  
 R-type:  
 0.125 (.025), 0.25 (0.05), 0.5 (0.1), 0.75 (0.25), 1.5 (0.25), 3 (0.5), 6 (1), 12 (2), 16 (4), 24 (4), 32 (8), 48 (8), 72 (16), 120 (20)

### 4. Range accuracy

1% of range in use or 15 m whichever is the greater

## 5. Bearing accuracy

$\pm 1^\circ$

## 6. Bearing discrimination

Better than  $2.5^\circ$  except S-band 10 ft radiators (SN-30AF)

## 7. Presentation modes

Head-up, Head-up TB, North-up, Course-up, True motion north-up  
(Automatically set to HU in case of compass failure)

## 8. Variable Range Markers

Two Variable Range Markers, switched

## 9. Electronic Bearing Lines

Two Electronic Bearing Lines, switched  
Range marker on EBL

## 10. Offcenter

IMO type: Sweep origin can be offcentered by 75% of range in use in any direction.  
Regular type: Any direction up to 100%

## 11. Target alarm zone

2 TAZ at 3 and 6 nm in width of 0.5 nm, any sector.

## 12. Electronic plotting (E-plot)

10 targets manual plotting. Not operative in ARPA mode.

## 13. Parallel index lines

2, 3 and 6 lines (selectable on menu)

## 14. Navigation lines (option)

Two lines to define a navigation channel (with RP-25)

## ARPA FUNCTIONS

### 1. Acquisition

Instant selection of auto or manual acquisition in 0.2 to 32 nm, relative speed 100 kt. Auto 20 targets plus manual 20 targets, or Manual 40 targets

### 2. Tracking

Automatic tracking of all acquired targets on the display for 5 out of 10 consecutive scans in 0.1 to 32 nm

### 3. Prediction of target motion

True or relative vectors, time scaled.  
Length: 1 to 99 min

### 4. Past positions

5 or 10 past positions of tracked targets at intervals of 2 min

## 5. Collision warning

CPA limit: 0.2 to 10 nm

TCPA limit: 0 to 99 min

## 6. Guard zone (Guard ring)

2 guard zones (guard rings) of operator-defined width in 0.7 to 32 nm, Sector 1 to  $360^\circ$  any direction

## 7. Trial maneuver

Simulates the effect on all tracked targets of own ship maneuver with course, speed and delay time.

## INTERFACING

### 1. IEC 61162-1

OSD, RSD, TTM, etc. (Listener 2 mA at 2V, Talker 60 mA max)

### 2. Analog

RGB video, H/V sync for VDR with optional board)

### 3. Gyrocompass

Built-in interface accepts synchro signal (20-50 V, 50-400 Hz) or stepper signal (20-50 VDC, any polarity).

### 4. Speed log (IEC 61192-1 interface)

IEC 61192-1 contact closure or 200/400/500 pulses/nm.

## POWER SUPPLY

### 1. FR/FAR-2815/2825

115/230 VAC, 1 $\phi$ , 470 VA(2815), 500 VA(2825), DC set not available

### 2. FR/FAR-2825W/2855/2855W

Display unit: 115/230 VAC, 1 $\phi$ , 500 VA (2825W), 115 VAC, 1 $\phi$ , 550 VA (2855/2855W)

Antenna unit: 115/230 VAC, 1 $\phi$ , 150 VA (2825W/2855W), 230 VAC, 3 $\phi$ , 120 VA, 380/440 VAC, 3 $\phi$ , 120 VA (2825W/2855W), 24 V, 30 W (2855)

### 3. FR/FAR-2835S/2835SW

Display unit: 115/230 VAC, 1 $\phi$ , 500 W

Antenna unit: 220 VAC, 50-60 Hz, 3 $\phi$ , 440 VA, 380/440 VAC, 50-60 Hz, 3 $\phi$ , 440 VA

### 4. FR/FAR-2865SW

Display unit: 115 VAC, 1 $\phi$ , 550 VA

Antenna unit: 220 VAC, 3 $\phi$ , 50-60 Hz, 440 VA, 380/440 VAC, 3 $\phi$ , 50-60 Hz, 440 VA

## PROGRAM NUMBER

### SPU Board

MAIN: 0359096132

SUB: 0359057134

### ARP Board

ARP: 1859038106

SUB: 18590399101

### RP Board

0359094111

## EQUIPMENT LIST

### Standard Supplies

1. Display unit  
Radar: RDP-115 (w/RP-25)  
ARPA: RDP-115A (w/ARP-25, RP-25)
2. Antenna unit with 30 m antenna cable
3. RF transceiver unit for RF-down system
4. PSU-004 for FR/FAR-2825W/2855W/  
2835S/2835SW/2865SW
5. PSU-001 for FR/FAR-2855
6. Standard spare parts and installation  
materials

### Optional Supplies

1. Waveguide for RF-down system  
(Coax cable for S-band)
2. Gyro interface GC-8
3. Interswitch box RJ-7 or 8
4. Performance monitor PM-30\* (X-band),  
PM-50\* (S-band)
5. 42 rpm scanner motor  
(FR/FAR-2815/2825 only)
6. 45 rpm scanner motor for HSC  
(FAR-2835S only)
7. Video plotter RP-25\*\*
8. ARPA Board ARP-25
9. Hand grip
10. Display pedestal
11. Interface unit IF-2300\*

\* Necessary in IMO-type Radar and ARPA

\*\* RP-25 (Radar Video Picture) necessary for  
all class of SOLAS ships for radar maps and  
navlines

\*\*\* ARP-25 (Auto Radar Plotter) may not be  
necessary on ships below 1,000 GT. Check  
with the Administrations.

## Category of Equipment Units

Equipment for Protected Area

- Display unit
- Power supply unit
- RF transceiver unit
- Interswitch unit

Equipment for Exposed

- Antenna unit
- Performance monitor

## Compass safe distance

See each corresponded Installation Manual.

# SYSTEM CONFIGURATION

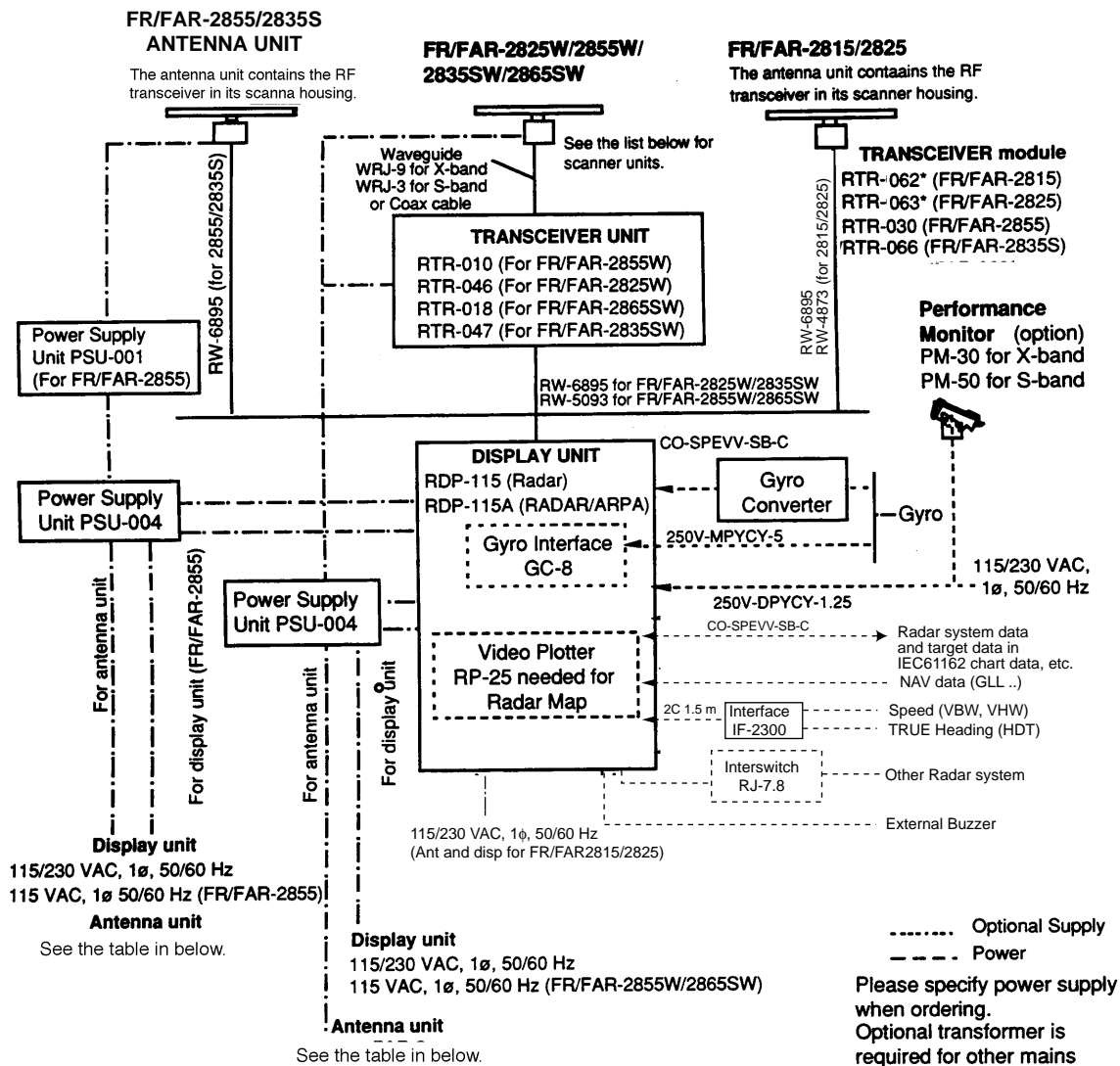

## ANTENNA UNIT (Turning unit or Gearbox)

Model	Antenna unit	Motor type
FR/FAR-2815	RSB-0074 (24 rpm, 24 VDC)*	D8G-516
	RSB-0075 (42 rpm, 24 VDC)*	D8G-571
FR/FAR-2825	RSB-0074 (24 rpm, 24 VDC)*	D8G-516
	RSB-0075 (42 rpm, 24 VDC)*	D8G-571
FR/FAR-2855	RSB-0049 (16 rpm (50 Hz)/20 rpm (60 Hz), 200/220 VAC, 3 $\phi$ )	GOB-8222
	RSB-0050 (20 rpm, 24 VDC)	RM-6585
FR/FAR-2825W FR/FAR-2855W	RSB-0076 (21 rpm (50 Hz)/26 rpm (60 Hz), 200/220 VAC, 3 $\phi$ ) *	RM-8123
	RSB-0077 (21 rpm (50 Hz)26 rpm (60 Hz), 380/440 VAC, 3 $\phi$ ) *	RM-8124
	RSB-0078 (21 rpm (50 Hz)26 rpm (60 Hz), 380/440 VAC, 1 $\phi$ ) *	RM-8247
FR/FAR-2835S	RSB-0026 (21 rpm (50 Hz)26 rpm (60 Hz), 200/220 VAC, 3 $\phi$ )	RM-7398
	RSB-0031 (21 rpm (50 Hz)26 rpm (60 Hz), 200/220 VAC, 3 $\phi$ )	RM-7435
	RSB-0088 (45 rpm, 220 VAC, 3 $\phi$ , 50 Hz) for HSC S-band	RM-9519
	RSB-0089 (45 rpm, 220 VAC, 3 $\phi$ , 60 Hz) HSC S-band	RM-9520
	RSB-0090 (45 rpm, 440 VAC, 3 $\phi$ , 60 Hz) HSC S-band	RM-9521
FR/FAR-2835SW	RSB-0027 (21 rpm (50 Hz)26 rpm (60 Hz), 200/220 VAC, 3 $\phi$ )	RM-7398
	RSB-0032 (21 rpm (50 Hz)26 rpm (60 Hz), 380/440 VAC, 3 $\phi$ )	RM-7435

NOTE: The gearboxes marked \* work with new radiators (such as XN12AF \*). The new radiator has different physical dimensions at the rotary joint and only fits on the new gear box. The slotted waveguide array radiators are the same as the current ones. The gearing and motors are the same as those in the former counterpart. Assembled antenna are compatible to each other within the same for RF output.

## RADIATOR

4 ft	Type XN-12AF*	8 ft	Type XN-4A, 24AF*	X-Band
6.5 ft	Type XN-3, 3A, 20AF*	10 ft	Type XN-5A	
12 ft	SN-36AF	10 ft	SN-30AF	S-Band
<b>NOTE: Radiators marked * for RSB-0074/0075/0076/0077/0078</b>				

# 1. OPERATION

## **WARNING**

Before turning on the radar, make sure that there is no one near the antenna unit. Serious injury or even death may result if a rotating antenna strikes someone standing nearby.

### 1.1 Turning on the Power

The POWER switch is located at the lower right corner of the display. Push it to switch on the radar set. To turn off the radar, push it again; the switch will extend. The screen shows the bearing scale and digital timer approximately 15 seconds after power-on. The timer counts down three minutes of warm-up time. During this period the magnetron, or the transmitter tube, is warmed for transmission. When the timer has reached 0:00, the legend STBY appears indicating that the radar is now ready to transmit pulses.

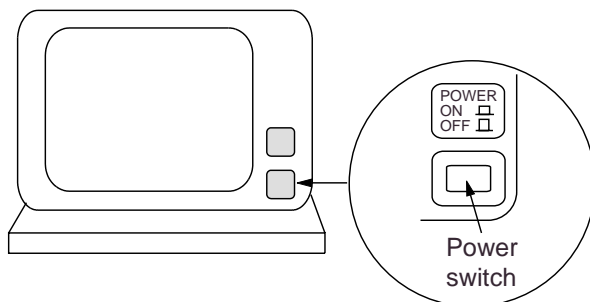

*Location of power switch*

In warm-up and standby condition, you will see the message BRG SIG MISSING. This is normal because a bearing signal is not yet generated when the antenna is not rotating. ON TIME and TX TIME values shown at the bottom of the screen are the time counts in hours and tenths of hour when the radar has been powered on and transmitted.

### 1.2 Transmitter ON

When the STANDBY status is displayed on the screen, press the Transmit switch labeled ST-BY/TX on the control panel of the display unit.

The radar is initially set to previously used range and pulsewidth. Other settings such as brilliance levels, VRMs, EBLs and menu option selections are also set to previous settings.

The Transmit switch toggles the radar between STANDBY and TRANSMIT status. The antenna stops in STANDBY status and rotates in TRANSMIT status.

#### Notes:

- 1) If the antenna does not rotate in TRANSMIT status, check whether the antenna switch in the tuning compartment is in the OFF position.
- 2) The magnetron ages with time resulting in a reduction of output power. It is highly recommended that the radar be set to STANDBY status when not used for an extended period of time.

#### Quick Start

Provided that the radar was once in use with the transmitter tube (magnetron) still warm, you can turn the radar into TRANSMIT condition without 3-minutes standby. If the Power Switch has been turned off by mistake or the like and you wish to restart the radar promptly, follow the steps below:

- Turn on the Power Switch not later than 5 sec after power-off.
- Press the ST-BY switch in the tuning compartment.
- Press the Transmit Switch STBY/TX.

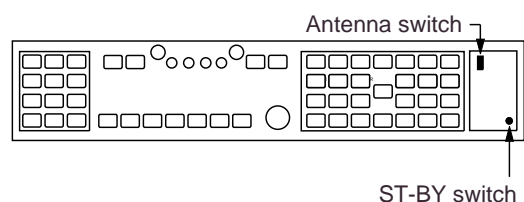



## 1.3 Controls

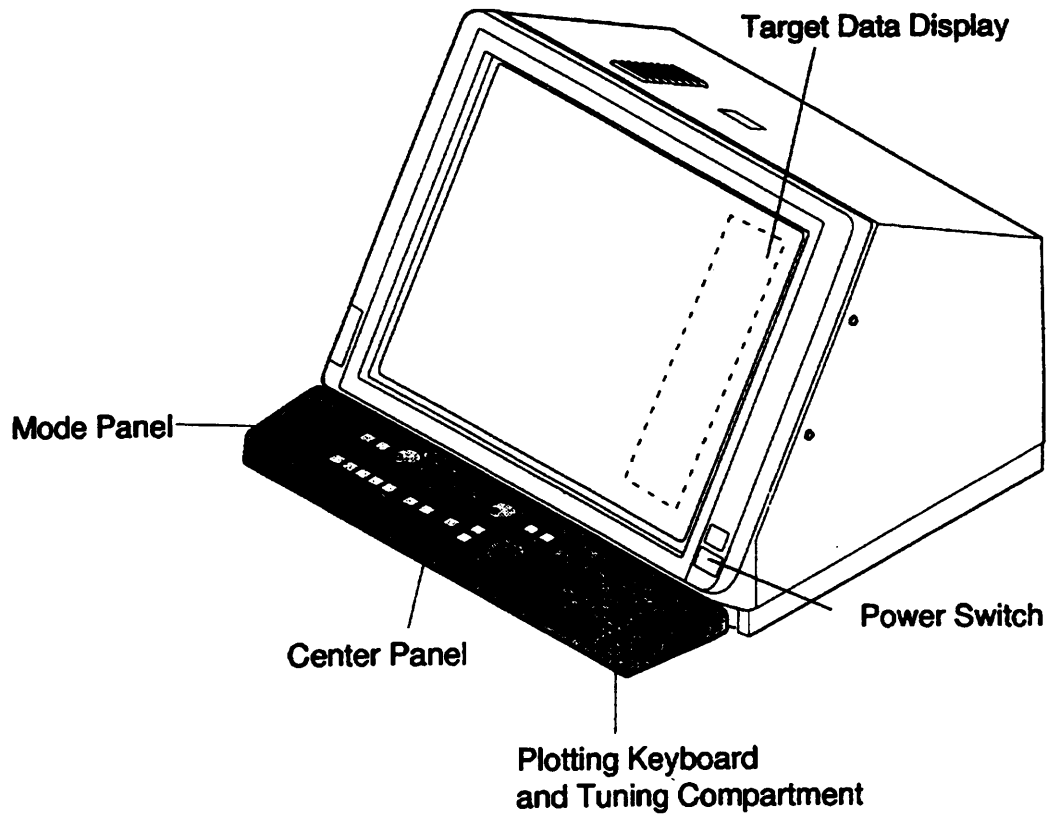

*FR-2805 Series Radar Display Unit Overview*

# Main control panel

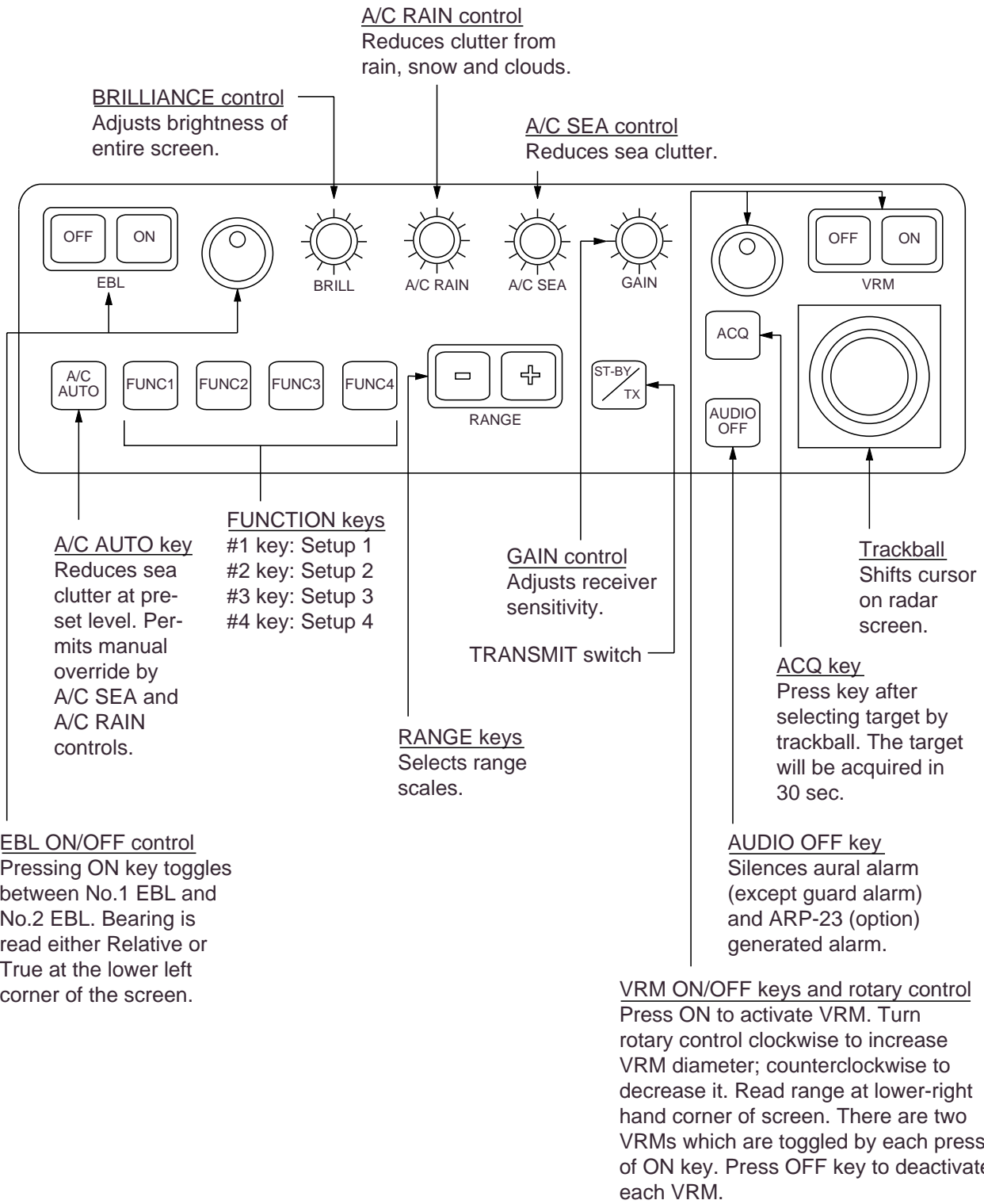

GAIN, A/C RAIN, A/C SEA and BRILL controls are of push-and-rotate type. Push in wanted switch lightly, and it will pop up. Rotate it to the wanted setting and push it in. The retracted position of the controls provides a better protection for water splash.

# Display controls

## Mode Panel

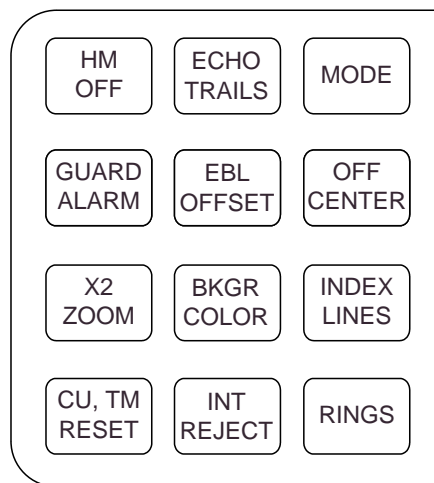

### HM OFF

Temporarily erases the heading marker.

### ECHO TRAILS

Shows trails of target echoes in the form of simulated afterglow.

### MODE

Selects presentation modes: Head-up, Head-up/TB, North-up, Course-up and True Motion.

### GUARD ALARM

Used for setting the guard alarm.

### EBL OFFSET

Activates and deactivates off-centering of the sweep origin.

### BKGR COLOR

Selects the background color.

### INDEX LINES

Alternately shows and erases parallel index lines.

### X2 ZOOM

Enlarges a user-selected portion of picture twice as large as normal. (R-type only)

### CU, TM RESET

Resets the heading marker to 000° in course-up mode; moves own ship position to 50% radius in stern direction in the true motion mode.

### INT REJECT

Reduces mutual radar interference.

### RINGS

Adjusts the brightness of range rings.

## Plotting keypad and tuning compartment

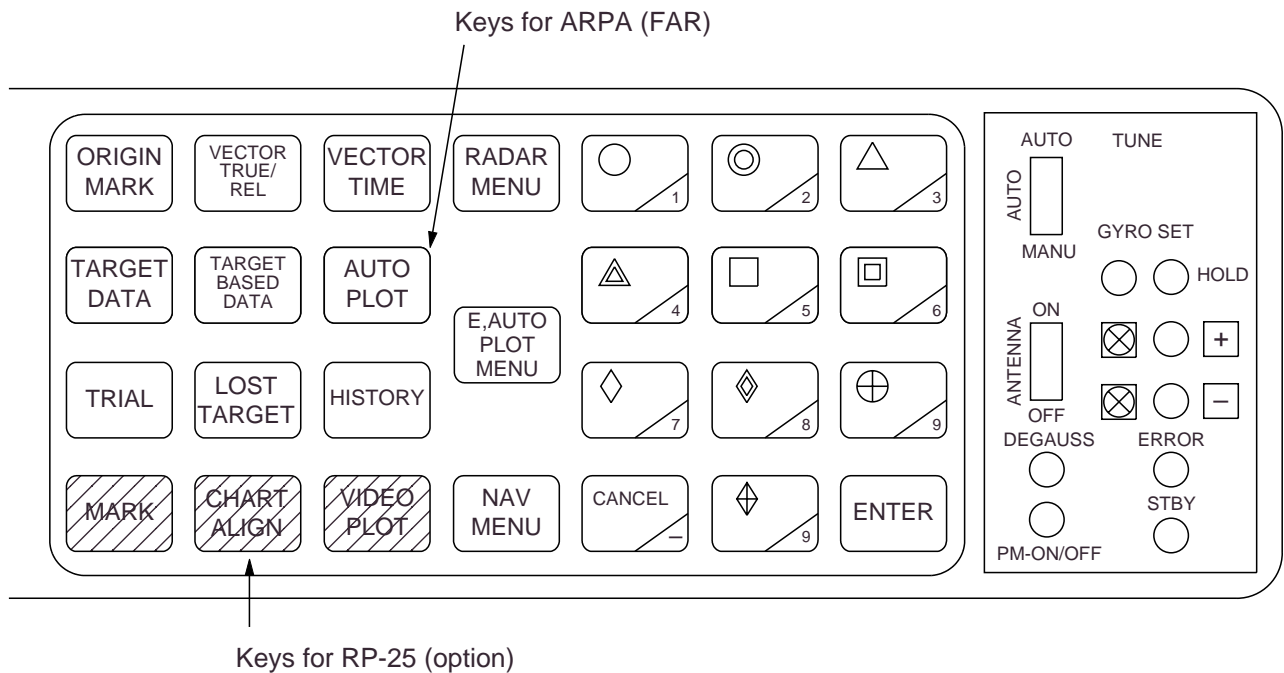

### ORIGIN MARK

Show and erases the origin mark (a reference point for range/bearing measurement).

### VECTOR TRUE/REL

Selects true or relative vector.

### VECTOR TIME

Sets vector length in time.

### RADAR MENU

Opens and closes RADAR menus.

### E-PLOT, AUTO PLOT MENU

Opens and closes E-Plot and optional AUTO PLOT menus.

### NAV MENU

Opens and closes NAV menu.

### Keys 0-9

Select plot symbols. Also used for entering numeric data.

### CANCEL

Terminates plotting of a specified target or all tracked targets.

### ENTER

Used to save settings on menu screen.

### Keys for ARPA (optional in R-type)

#### TARGET DATA

Displays the acquired target data.

#### TARGET BASED DATA

Own ship's speed is measured relative to a fixed target.

#### AUTO PLOT

Activates and deactivates the Auto Plotter.

#### TRIAL

Initiates a trial maneuver.

#### LOST TARGET

Silences the lost target audible alarm and erases the lost target symbol.

#### HISTORY

Shows and erases past positions of tracked targets.

### Keys for Video Plotter (optional)

MARK Enter/erase marks

#### CHART ALIGN

Used to align chart data.

#### VIDEO PLOT

Turns the video plotter on/off.

## 1.4 CRT Brilliance

Operate the BRILL control on the control panel of the display unit to adjust the entire screen brightness. Note that the optimum point of adjustment varies with ambient light conditions, especially between daytime and nighttime.

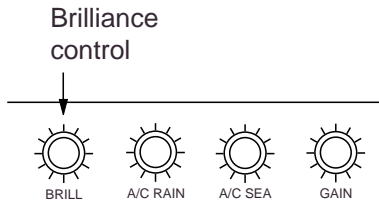

**Note:** The CRT brilliance should be adjusted before adjusting relative brilliance levels on the BRILLIANCE menu to be explained later.

## 1.5 Tuning the Receiver

### Auto tune

The radar receiver is tuned automatically each time the power is turned on, thus there is no front panel control for tuning purpose. The tuning indicator and the label AUTO TUNE at the top right corner of the display unit show the tuning circuit is working. If the label AUTO TUNE is not displayed, check that the TUNE selector in tuning compartment is in the AUTO position.

### Manual tune

If you are not satisfied with the current auto tune setting, follow these steps to fine-tune the receiver:

1. Set the TUNE selector in the tuning compartment to MAN for manual tuning.

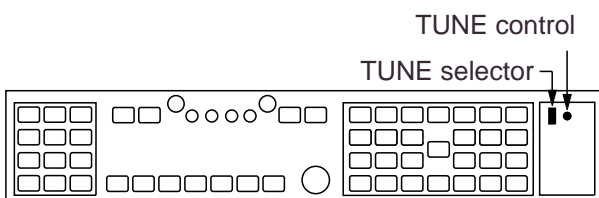

2. Push the tune control so that it pops up.
3. While observing the picture on the 48 mile scale, slowly adjust TUNE control and find the best tuning point.
4. So the TUNE selector to AUTO and wait for about 10 seconds or four scanner rotations.
5. Make sure that the radar has been set to the best tuning point. This condition is where the tuning indicator lights to about 80% of its total length.
6. Push the TUNE control into the retracted position.

### Video Lockup Recovery

Video lockup, or picture freeze, can occur unexpectedly on digital rasterscan radars. This is mainly caused by heavy spike noise in the power line and can be noticed by carefully watching the nearly invisible sweep line. If you suspect that the picture is not updated every scan of the antenna or no key entry is accepted notwithstanding the apparently normal picture, do Quick Start to restore normal operation:

1. Turn of the power switch and turn it on again within five seconds.
2. Push the ST-BY switch in the tuning compartment.
3. Push the Transmit switch labeled ST-BY/TX for Transmit status.

This LED lights if video lockup is associated with fundamental malfunction of CPU.

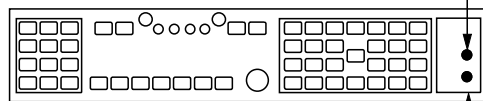

ST-BY switch for quick start

# 1.6 On-screen Legends and Markers

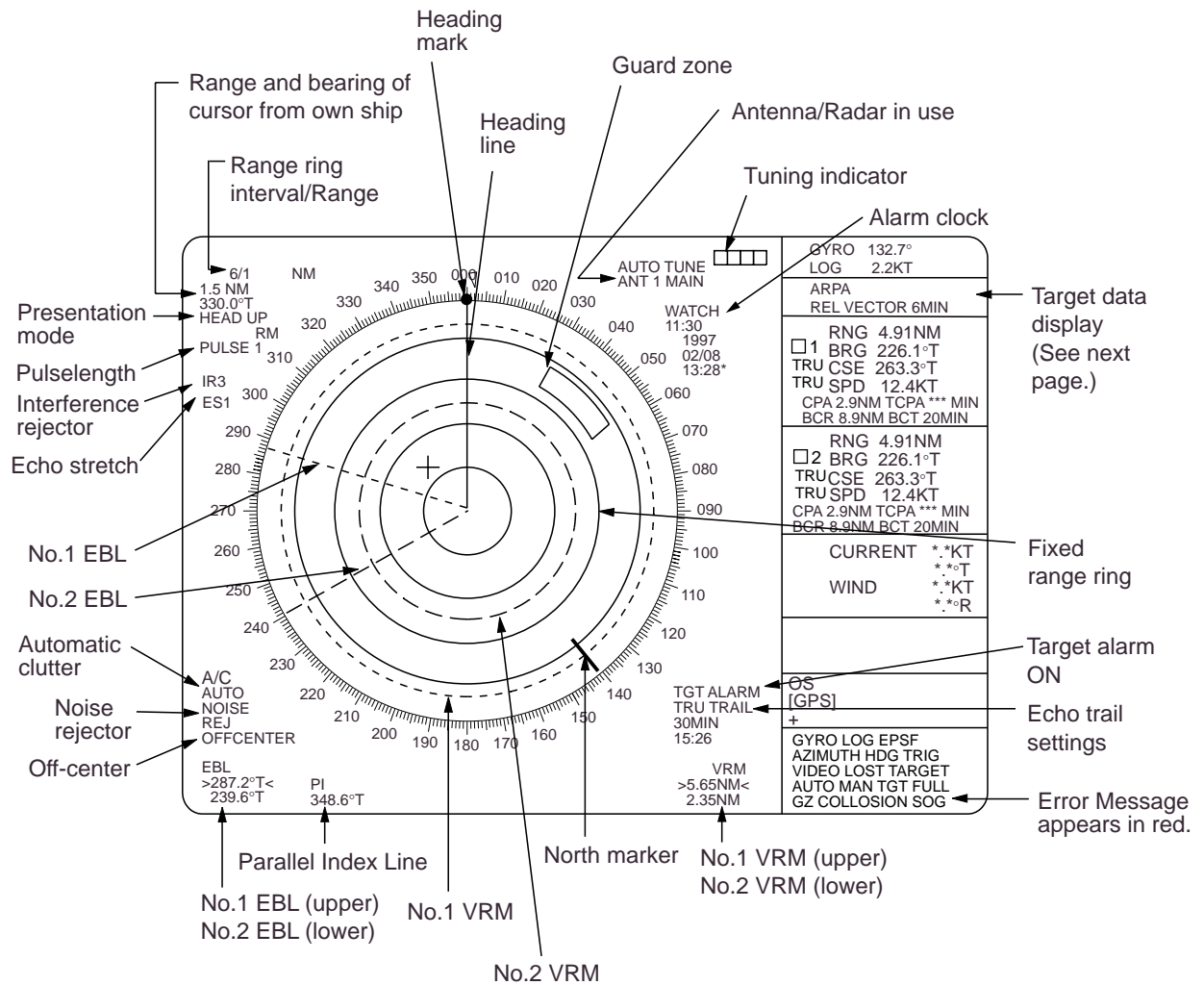

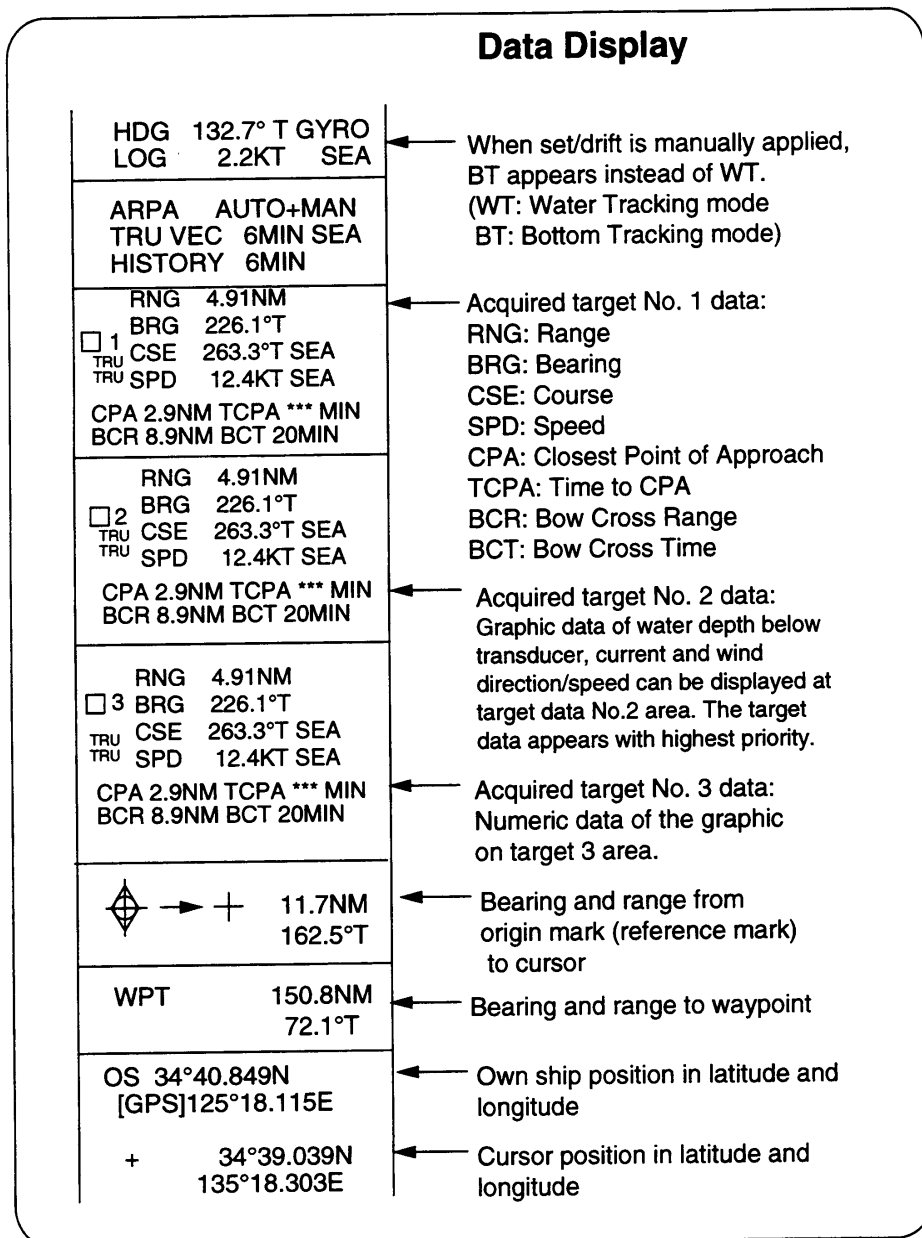

## 1.7 Degaussing the CRT Screen

Each time the radar is turned on, the degaussing circuit automatically demagnetizes the CRT screen to eliminate color contamination caused by earth's magnetism or magnetized ship structure.

The screen is also degaussed automatically when own ship has made a significant course change. While being

degaussed, the screen may be disturbed momentarily with vertical lines. If you wish to degauss by manual operation at an arbitrary time, open and press the "DE-GAUSS" switch.

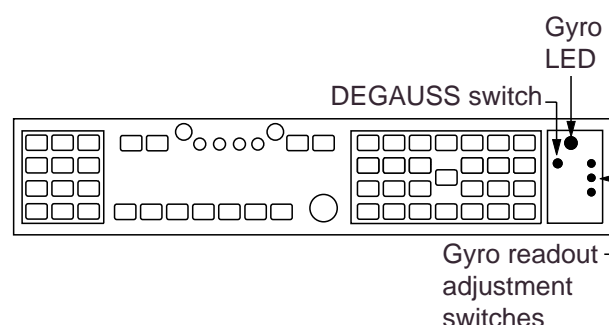

## 1.8 Initializing the Gyro Readout

Provided that your radar is interfaced with a gyrocompass, ship's heading is displayed at the top of the screen. Upon turning on the radar, align the on-screen GYRO readout with the gyrocompass reading by the procedure shown below. Once you have set the initial heading correctly, resetting is not usually required. However, if the GYRO readout goes wrong for some reason, repeat the procedure to correct it.

1. Open the tuning compartment and press the HOLD button. The Gyro LED lights.

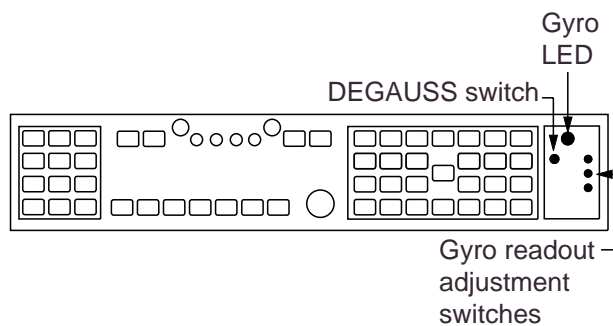

2. Press the UP or DOWN button to duplicate the gyrocompass reading at the on-screen GYRO readout. Each press of these buttons changes the readout by 0.1-degree steps. To change the readout quickly, hold the UP or DOWN button for over two seconds.
3. Press the HOLD switch when the on-screen GYRO readout has matched the gyrocompass reading. The Gyro LED goes out.

**Note:** The HOLD button is used to disengage the built-in gyro interface from the gyrocompass input in the event that you have difficulty in fine-adjusting the GYRO readout due to ship's yawing, for example. When initializing the GYRO readout at a berth (where the gyrocompass reading is usually stable), you may omit steps 1 and 3 above.

## 1.9 Presentation Modes

This radar has the following presentation modes:

### Relative Motion (RM)

- Head-up: Unstabilised
- Head-up TB: Head-up with compass-stabilized bearing scale (True Bearing)
- Course-up: Compass-stabilized relative to ship's intended course
- North-up: Compass-stabilized with reference to north

### True Motion (TM)

- North-up: Ground or sea stabilized with compass and speed inputs

### Selecting presentation mode

Press the MODE key on the mode panel. Each time the MODE key is pressed, the presentation mode and mode indication at the upper-left corner of the screen change cyclically.

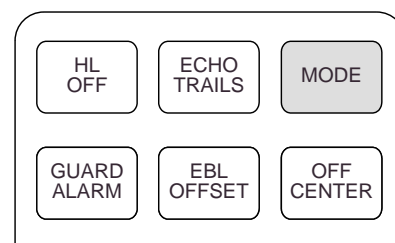

### Loss of Gyro Signal

When the gyro signal is lost, the presentation mode automatically becomes head-up and the GYRO readout at the screen top shows asterisks (\*\*.\*). The message SET HEADING appears at the lower-left corner of the screen. This warning stays on when the gyro signal is restored, to warn the operator that the readout may be unreliable. Press the MODE key to select another presentation mode (the asterisks are erased at this point). Then, align the GYRO readout with the gyrocompass reading and press the CANCEL key to erase the message SET HEADING.

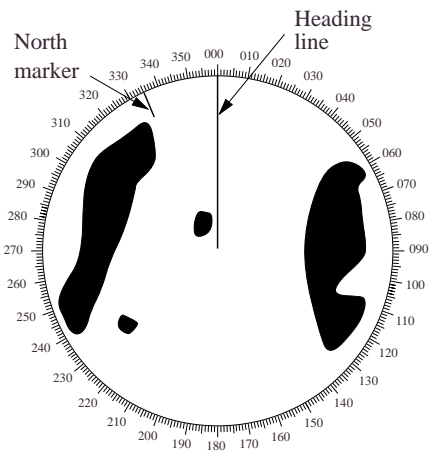
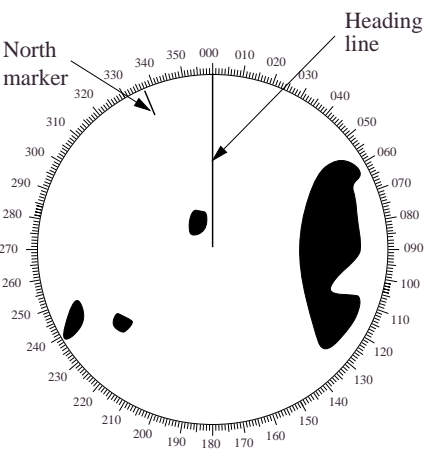
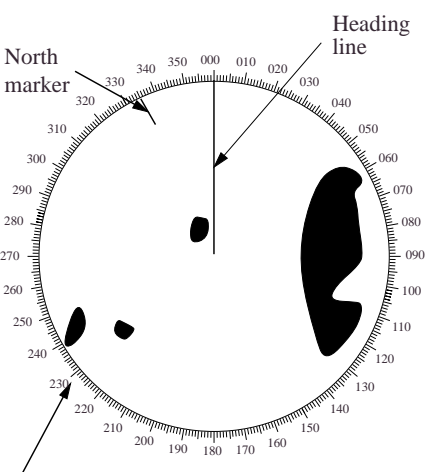

Presentation mode, representative display	Description
	<p><b>Head-up Mode</b></p> <p>A display without azimuth stabilization in which the line connecting the center with the top of the display indicates own ship's heading.</p> <p>The target pips are painted at their measured distances and in their directions relative to own ship's heading.</p> <p>A short line on the bearing scale is the north marker indicating compass north. A failure of the gyro input will cause the north marker to disappear and the GYRO readout to show asterisks (**.*) and the message SET HDG appears on the screen.</p>
	<p><b>Course-up Mode</b></p> <p>An azimuth stabilized display in which a line connecting the center with the top of the display indicates own ship's intended course (namely, own ship's previous heading just before this mode has been selected). Target pips are painted at their measured distances and in their directions relative to the intended course which is maintained at the 0-degree position while the heading marker moves in accordance with ship's yawing and course changes. This mode is useful to avoid smearing of picture during course change. After a course change, press the [CU, TM RESET] key to reset the picture orientation if you wish to continue using the course-up mode.</p>
 <p>The bearing scale rotates with a compass signal.</p>	<p><b>Head-up TB (True Bearing) Mode</b></p> <p>Radar echoes are shown in the same way as in the head-up mode. The difference from normal head-up presentation lies in the orientation of the bearing scale. The bearing scale is compass stabilized, that is, it rotates in accordance with the compass signal, enabling you to know own ship's heading at a glance.</p> <p>This mode is available only when the radar is interfaced with a gyrocompass.</p>

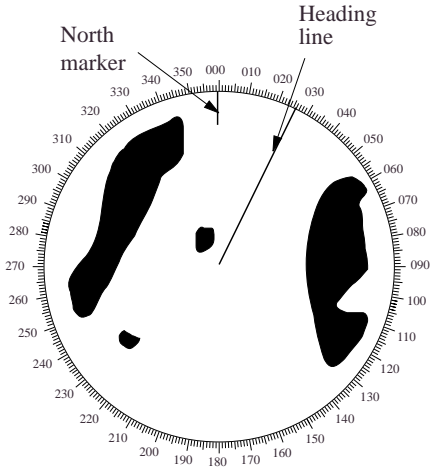
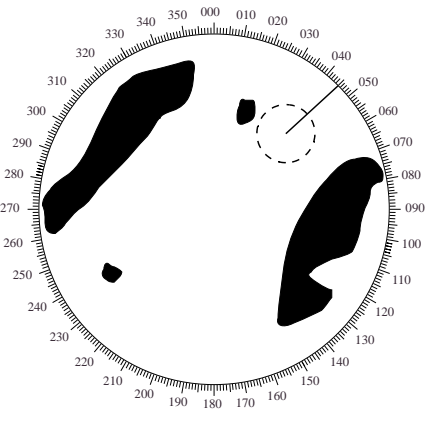
Presentation mode, representative display	Description
 <p>A circular radar display with a heading scale from 000 to 360 degrees. A 'North marker' is at 000 degrees and a 'Heading line' is at approximately 020 degrees. Two large black landmasses are visible on the left and right sides of the display.</p>	<p><b>North-up Mode</b></p> <p>In the north-up mode, target pips are painted at their measured distances and in their true (compass) directions from own ship, north being maintained UP of the screen. The heading marker changes its direction according to the ship's heading.</p> <p>If the gyrocompass fails, the presentation mode changes to head-up and the north maker disappears. Also, the GYRO readout shows asterisks (**.*) and the message SET HEADING appears at the lower-left corner of the screen.</p>
 <p>A circular radar display similar to the one above, but with a dashed circle around the center representing the 75% radius limit. The heading line is at 020 degrees.</p>	<p><b>True Motion Mode</b></p> <p>Own ship and other moving objects move in accordance with their true courses and speeds. All fixed targets, such as landmasses, appear as stationary echoes.</p> <p>When own ship reaches a point corresponding to 75% of the radius of the display, the own ship is automatically reset to a point of 50% radius opposite to the extension of the heading marker passing through the display center. Resetting can be made at any moment before the ship reaches the limit by pressing the [CU, TM RESET] key. Automatic resetting is preceded by a beep sound.</p> <p>If the gyrocompass fails, the presentation mode is changed to the head-up mode and the north marker disappears. The GYRO readout at the top of the screen shows asterisks (**.*) and the message SET HEADING appears at the lower-left corner of the screen.</p>

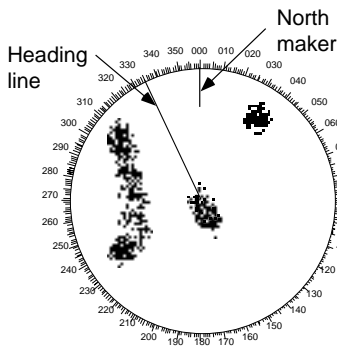

(a) True motion is selected

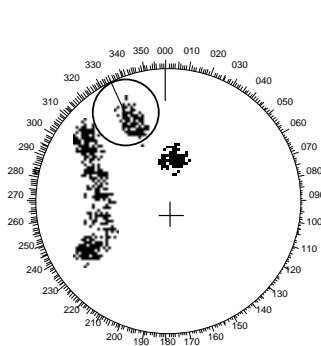

(b) Own ship has reached a point 75% of display radius

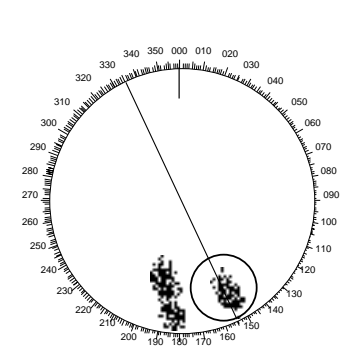

(c) Own ship is automatically reset to 50% of radius

Automatic resetting of sweep center in true motion mode

## 1.10 Selecting the Range Scale

The display range scale is changed in 13 steps on the R-type (11 steps on the IMO-type) by pressing the [+] and [-] keys. The selected range scale and range ring interval are shown at the upper left corner on the screen.

The display range can be expanded by 75% (100% in R-type) in any direction by using the off-centering control.

## 1.11 Selecting the Pulsewidth

The pulsewidth in use is displayed at the upper-left position of the screen using the abbreviations shown in the table above.

Appropriate pulsewidths are preset to individual range scales and function keys. Therefore, you are not usually required to select them. If you are not satisfied with the current pulsewidth settings, however, it is possible to change them by the Radar menu operation shown below.

You can choose the pulsewidth 1 or 2 on the scales 0.5 to 24 nm ranges on X-band models (0.75 to 24 nm ranges on S-band models).

### Selecting pulsewidth 1 or 2

1. Press the RADAR MENU key on the plotting keypad to show the FUNCTIONS menu.
2. Press the [1] key to select menu item 1 PULSEWIDTH.
3. Press the [1] key to select (or highlight) PULSEWIDTH 1 OR 2 as appropriate.
4. Press the ENTER key to conclude your selection followed by the RADAR MENU key to close the FUNCTION menu.

Legend	Pulsewidth	
	X-band	S-band
S (Short pulse)	–	0.08 $\mu$ s
S1 (Short pulse 1)	0.07 $\mu$ s	–
S2 (Short pulse 2)	0.15 $\mu$ s	–
M1 (Medium pulse 1)	0.3 $\mu$ s	0.3 $\mu$ s
M2 (Medium pulse 2)	0.5 $\mu$ s	0.6 $\mu$ s
L (Long pulse)	1.2 $\mu$ s	1.2 $\mu$ s

For FR/FAR-2855, 2855W and 2565SW, 0.3  $\mu$ s becomes 0.2  $\mu$ s.

### Presetting pulsewidths 1 and 2

Pulsewidth 1 and 2 can be preset on the Pulsewidth 1 and 2 menus. Shown below are examples of the pulsewidth setup procedure:

1. To enable selection of S1 (0.07  $\mu$ s) and S2 (0.15  $\mu$ s) pulsewidth on the 0.5 nm range on an X-band model, select S1 at 0.5 nm on the PULSEWIDTH 1 menu and S2 at 0.5 nm on the PULSEWIDTH 2 menu.
2. To enable selection of S2 (0.15  $\mu$ s) and M1 (0.3  $\mu$ s) pulsewidth on the 3 nm range on an X-band model, select S2 at 3 nm in the PULSEWIDTH 1 menu and M1 at 3 nm in the PULSEWIDTH 2 menu.

A longer pulse provides an increased detection range, but with reduced discrimination. If you need discrimination in preference to detection, choose a shorter pulse.

**Example:** To select S1 (0.07  $\mu$ s) as Pulsewidth 1 for the 0.5 nm range, display the PULSEWIDTH 1 menu following the steps shown above and hit the [2] key to choose "2 0.5 NM." Further hit the [2] key until the menu option "S1" is highlighted to the right of "2 0.5 NM."

**Note:** For FR-2815/2825, the menus on the next page are for the R-type. Refer to paragraph 1.32 or the menus on the IMO type.

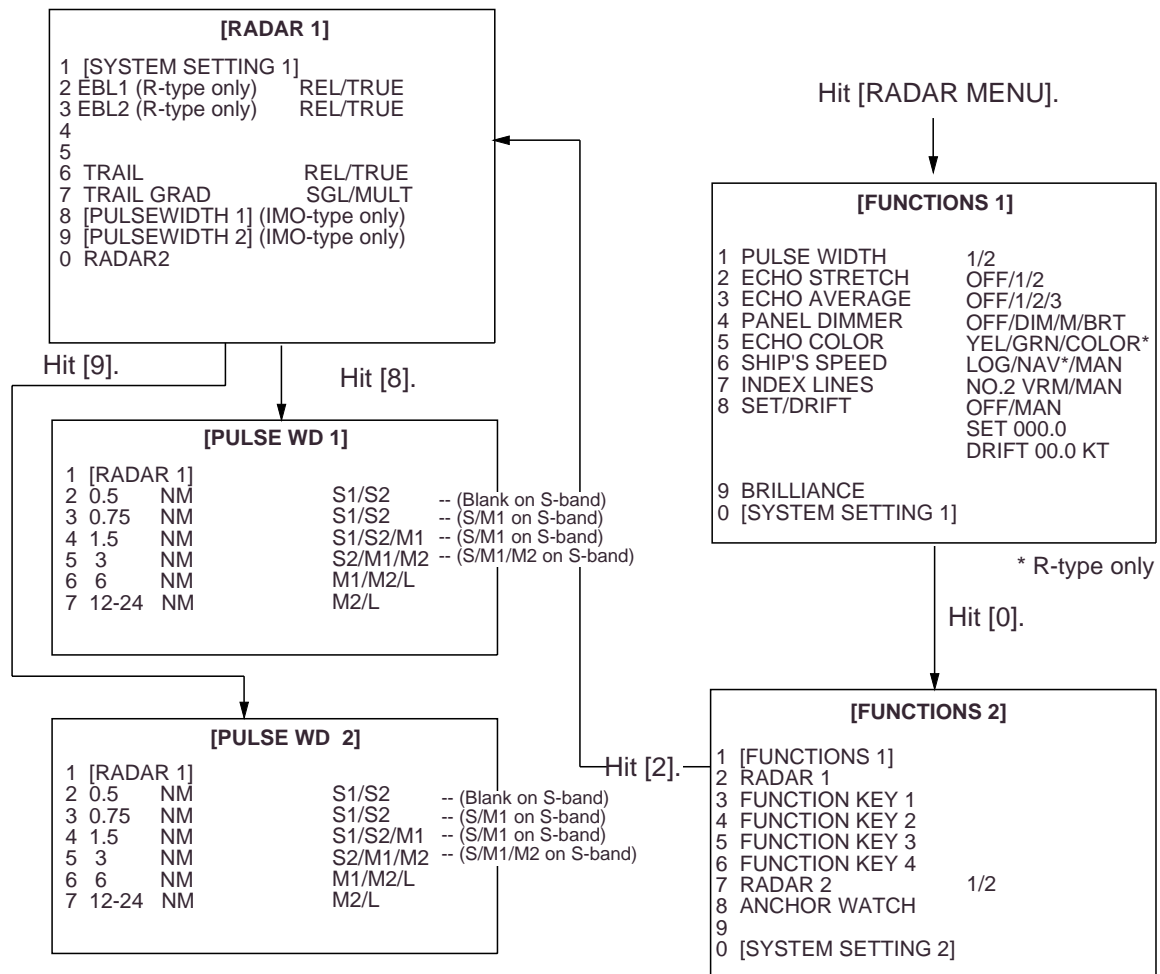

## 1.12 Adjusting the Sensitivity

The GAIN control is used to adjust the sensitivity of the receiver, and thus the intensity of echoes as they appear on the screen. It should be adjusted so that speckled background noise is just visible on the screen.

To become acquainted with the way the GAIN control works, try rotating it between fully counterclockwise and clockwise positions while observing the radar picture. You will notice that clockwise rotation increases the echo intensity level. A low gain setting results in the loss of weak echoes and a reduced detection range. If you turn the GAIN control too far clockwise for an excessive gain setting, desired echoes will be masked in the strong background noise.

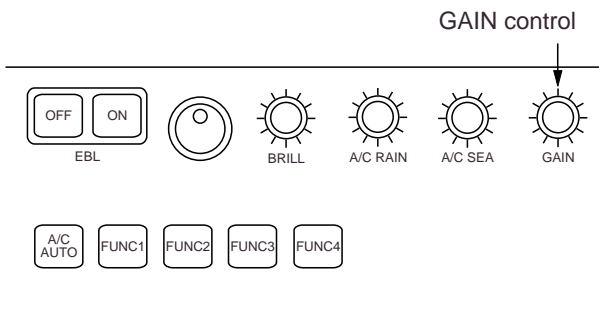

## 1.13 Suppressing Sea Clutter

In rough weather conditions returns from the sea surface are received over several miles around own ship and mask close targets. This situation can be improved by properly adjusting the A/C SEA (Anti-Clutter Sea) control.

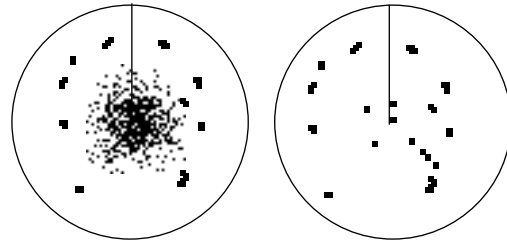
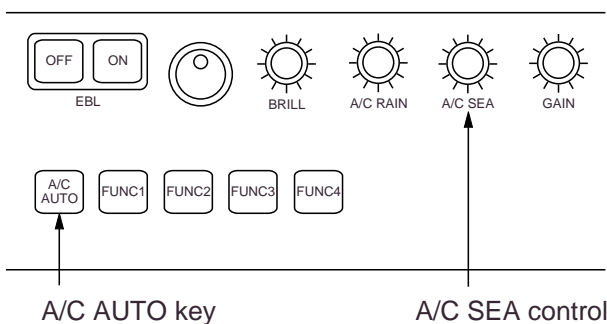

*A/C SEA control  
off*

*A/C SEA control  
adjusted*

## Automatic anti-clutter control

The easiest way to suppress the surface clutter is to use the automatic control. Press the A/C AUTO key next to the EBL rotary control at the left corner on the control panel. Use of a function key is also a good method for reducing sea clutter. For this purpose, presetting is required. Consult a FURUNO representative.

### **CAUTION**

The auto A/C function can erase weak targets.

## Manual anti-clutter control

From the fully counterclockwise position, slowly turn the A/C SEA control clockwise. For optimum target detection, you should leave speckles of the surface return slightly visible.

The anti-clutter sea control is often referred to as STC (Sensitivity Time Control) which decreases the amplification of the receiver immediately after a radar pulse is transmitted, and progressively increases the sensitivity as the range increases.

A common mistake is to over-adjust the A/C SEA control so that the surface clutter is completely removed. By rotating the control fully clockwise, you will see how dangerous this can be; a dark zone is created near the center of the screen and close-in targets can be lost. This dark zone is even more dangerous if the gain

has not been properly adjusted. Always leave a little surface clutter visible on the screen. If no surface clutter is observed (on a very calm water), set the control at the fully counterclockwise position.

### 1.14 Suppressing Precipitation Clutter

In adverse weather conditions, clouds, rain or snow produce a lot of spray-like spurious echoes and impairs target detection over a long distance. This situation can be improved by using a function key provided that it is so programmed. If the function key fails to offer a favorable suppression of the rain clutter, adjust the A/C RAIN control on the front control panel.

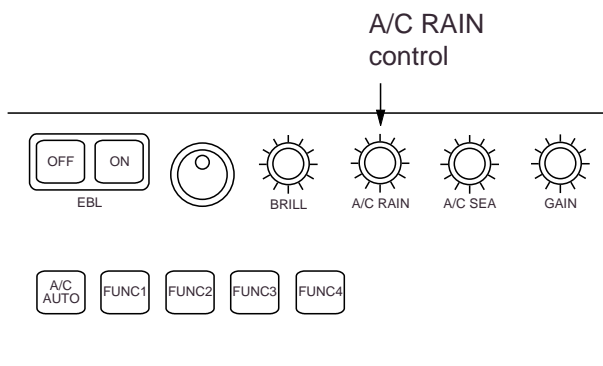

The A/C RAIN control adjusts the receiver sensitivity as the A/C SEA control does but rather in a longer time period (longer range). Clockwise rotation of this control increases the anti-clutter effect.

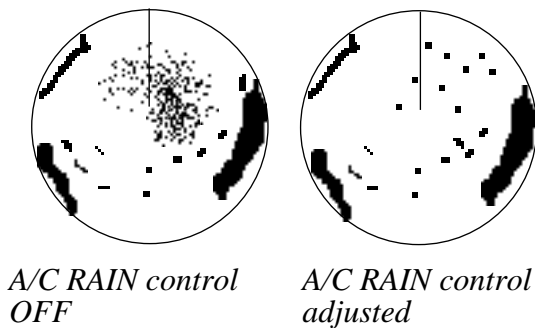

### 1.15 Interference Rejector

Mutual radar interference may occur in the vicinity of another shipborne radar operating in the same frequency band (9 GHz for X-band, 3 GHz for S-band). It is seen on the screen as a number of bright spikes either in irregular patterns or in the form of usually curved spoke-like dotted lines extending from the center to the edge of the picture. This type of interference can be reduced by activating the interference rejector circuit.

The interference rejector is a kind of signal correlation circuit. It compares the received signals over successive transmissions and suppresses randomly occurring signals. There are three levels of interference rejection depending on the number of transmissions that are correlated. These are indicated by the legends IR1, IR2 and IR3 at the upper-left position of the screen.

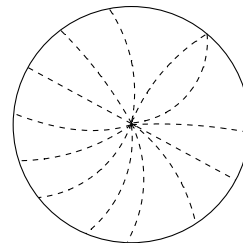

*Mutual radar interference*

Press the INT REJECT key to activate the interference rejector circuit. Successive presses of the key increase the effect of interference rejection, up to level 3. A fourth press deactivates the interference rejector. Switch off the interference rejector when no interference exists; otherwise weak targets may be lost.

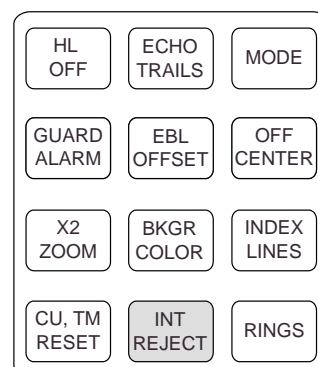

*Inside mode panel*



**Note:** For stable reception of certain types of radar beacons (racons) or SART (Search and Rescue Radar Transponder) as required by SOLAS 1974 as amended 1988 (GMDSS), it is recommended to turn the interference rejector off.

## 1.16 Measuring the Range

Use the fixed range rings to obtain a rough estimate of the range to a target. They are concentric solid circles about own ship, or the sweep origin. The number of rings is automatically determined by the selected range scale and their interval is displayed at the upper-left position of the screen. Press the RINGS key on the mode panel to show the fixed range rings if they are not displayed. Successive presses of the RINGS key gradually increase their brightness in 4 steps and fifth press erases the range rings.

Use the Variable Range Markers (VRMs) for more accurate measurement of the range to a target. There are two VRMs, No.1 and No.2, which appear as dashed rings so that you can discriminate them from the fixed range rings. The two VRMs can be distinguished from each other by different lengths of dashes.

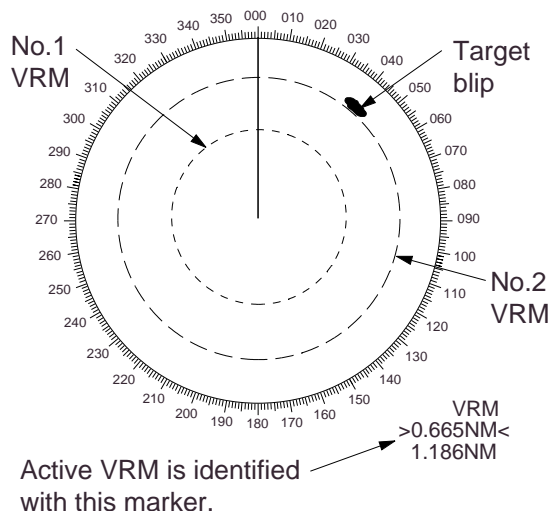

*Measuring the range*

Press the VRM ON key to display either of the VRMs.

Successive presses of the VRM ON key toggle the active VRM between No.1 and No.2 and the currently active VRM read-out is circumscribed by >.....<.

Align the active VRM with the inner edge of the target of interest and read its distance at the lower-right corner of the screen. Each VRM remains at the same geographical distance when you operate the RANGE+ or RANGE- key. This means that the apparent radius of the VRM ring changes in proportion to the selected range scale.

Press the VRM OFF key to key to erase each VRM.

## 1.17 Measuring the Bearing

Use the Electronic Bearing Lines (EBLs) to take bearings of a target. There are two EBLs, No.1 and No.2, which are toggled by successive presses of the EBL ON key. Each EBL is a straight dashed line extending out from the own ship position up to the circumference of the radar picture. The fine dashed line is the No.1 EBL and the coarse dashed one is the No.2 EBL.

Press the EBL ON key to display either of the EBLs.

Successive presses of the EBL ON key toggle the active EBL between No.1 and No.2 and the currently active EBL read-out is circumscribed by >...<.

Rotate the EBL rotary control clockwise or counterclockwise until the active EBL bisects the target of interest, and read its bearing at the lower-left corner of the screen.

The EBL readout is affixed by "R" (relative) if it is relative to own ship's heading, "T" (true) if it is referenced to the north, as determined by RADAR 2 menu settings.

Each EBL carries a range marker, or a short line crossing the EBL at right angles and its distance from the EBL origin is indicated at the VRM readout whether or

not the corresponding VRM is displayed. The range marker changes its position along the EBL with the rotation of the VRM control.

Press the EBL OFF key to erase each EBL.

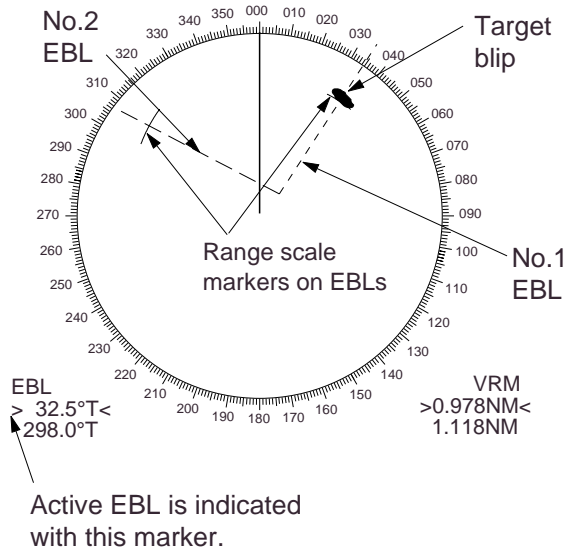

## 1.18 Collision Assessment by Offset EBL

The origin of the EBL can be placed anywhere with the trackball to enable measurement of range and bearing between any targets. This function is also useful for assessment of the potential risk of collision. To assess possibility of collision:

1. Press the EBL ON key to display or activate an EBL (No.1 or 2).
2. Place the cursor (+) on a target of interest (A in the illustrated example) by operating the trackball.
3. Press the EBL OFFSET key on the mode panel, and the origin of the active EBL shifts to the cursor position. Press the EBL OFFSET key again to anchor the EBL origin.
4. After waiting for a few minutes (at least 3 minutes), operate the EBL control until the EBL bisects the target at the new position (A'). The EBL readout shows the target ship's course, which may be true or relative depending on the settings on the RADAR 2 menu.

If relative motion is selected, it is also possible to read CPA (Closest Point of Approach) by using a VRM as shown below (Figure (a)). If the EBL passes through the sweep origin (own ship) as illustrated (Figure (b)), the target ship is on a collision course.

5. To return the EBL origin to the own ship's position, press the EBL OFFSET key again.

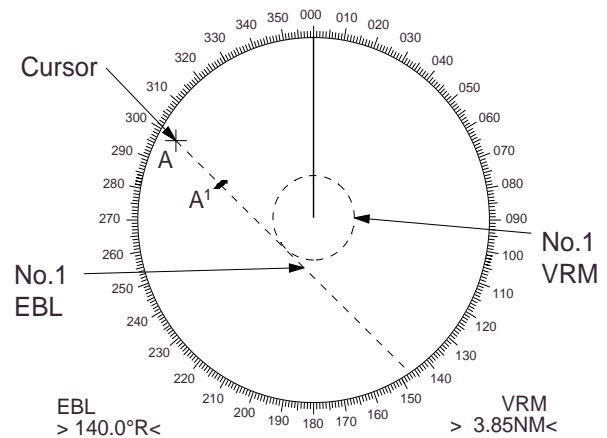

(a) Evaluating target ship's course and CPA in relative motion mode

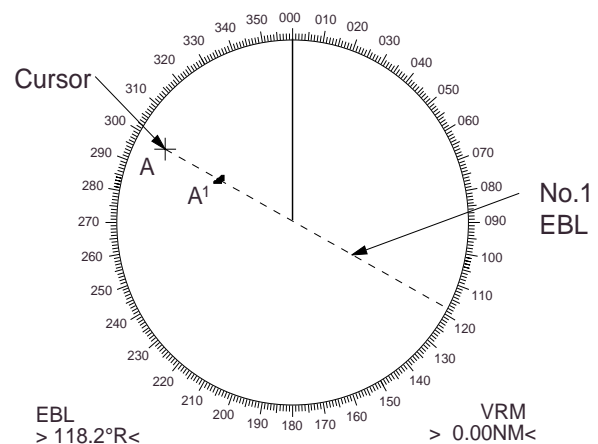

(b) Target ship on collision course



## 1.19 Measuring Range and Bearing Between Two Targets

Press the EBL OFFSET key, and place the origin of No.1 EBL, for example, on a target of interest (target 1 in the illustrated example) by operating the trackball.

Turn the EBL control until the EBL passes through another target of interest (target 2).

Turn the VRM control until the range marker aligns with target 2. The active VRM readout at the lower-right corner of the screen indicates the distance between the two targets.

You can repeat the same procedure on third and fourth targets (targets 3 and 4) by using No.2 EBL and No.2 VRM.

Bearing is shown relative to own ship with suffix "R" or as a true bearing with suffix "T" depending on EBL relative/true settings on the RADAR 2 menu. To return the EBL origin to the own ship position, press the EBL OFFSET key again.

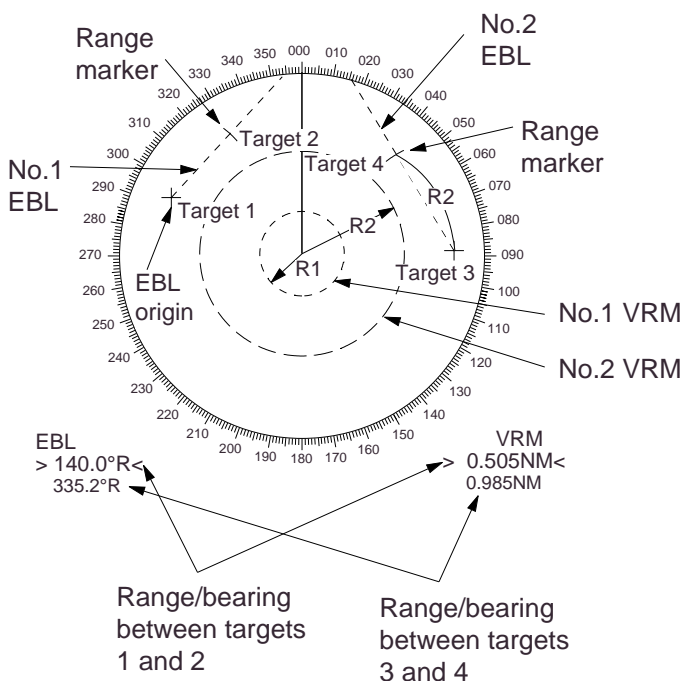

## 1.20 Setting a Guard Zone (Guard Alarm)

### CAUTION

The guard zone (guard alarm) feature should never be relied upon as the sole means for detecting the risk of potential collision. The operator of a ship is not relieved of the responsibility to keep visual lookout for avoiding collisions, whether or not the radar is in use.

A guard zone (guard alarm) may be set to alert the navigator to targets (ships, landmasses, etc.) entering a certain area with visual and audible alarms.

The guard zone (guard alarm) has a fixed width of 0.5 nm in the radial direction and is adjustable only within 3.0 to 6.0 nm from own ship. The guard zone (guard alarm) can be set to any sector angle between 0 and 360 degrees in any direction.

To set a guard zone (guard alarm):

1. Place the cursor (+) at point "A" (see figure at the top of the next page) using the trackball and press the GUARD ALARM key on the mode panel (left key group). The message SET GUARD appears at the bottom-right corner of the screen.

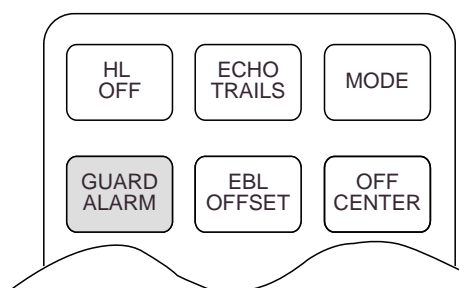

*Inside mode panel*

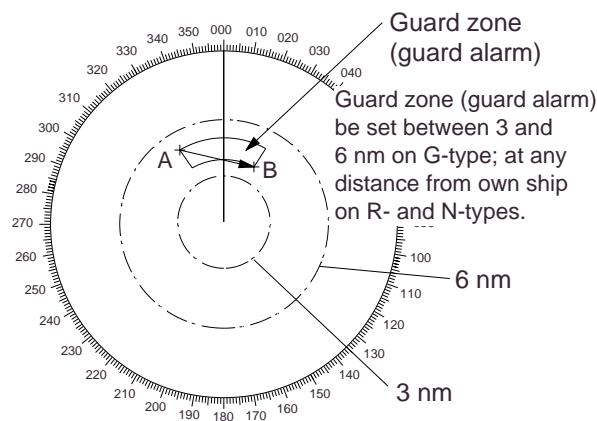

2. Move the cursor (+) to point "B" and press the GUARD ALARM key. Then, a guard zone (guard alarm) as illustrated is created and the label GUARD appears instead of SET GUARD at the lower-right corner of the screen.

**Note:** If you wish to create a guard zone (guard alarm) having a 360-degree coverage around own ship, set point "B" in almost the same direction (approx.  $\pm 3^\circ$ ) as point "A" and press the GUARD ALARM key.

### Silencing audible alarm, reactivating guard alarm

A target entering the guard zone (guard alarm) produces both visual (flashing) and audible (beeping) alarms. To silence the audible alarm, press the GUARD ALARM key, and the label GUARD ACK replaces GUARD on the display.

This will deactivate the audible alarm but will not stop the flashing of the target in the guard zone (guard alarm). To reactivate the audible alarm, press the GUARD ALARM key again.

### Disabling guard zone (guard alarm)

Hold the GUARD ALARM key depressed for at least 3 seconds.

**Note:** The guard alarm is given to targets having a certain level of echo strength. This level does not always imply a land-mass, reef, ships or other surface objects but can mean returns from the sea surface or precipitation. Properly adjust the

GAIN, A/C SEA, and A/C RAIN controls to reduce noise to avoid generation of guard alarm against false target detection.

### Inward and outward guard alarms

On the R-type, an inward or outward guard alarm can be selected on the RADAR 2 menu. On the IMO type, only the inward guard alarm is available. The inward guard alarm generates visual and audible warnings when an approaching target enters the guard zone (guard alarm) from any direction. The outward guard alarm is produced when a target leaves the guard zone.

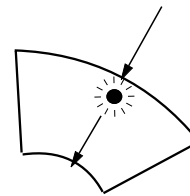

(a) *Inward guard alarm available on IMO and R-types*

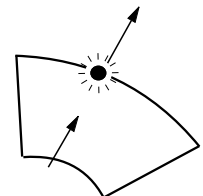

(b) *Outward guard alarm available on R-type only*

### 1.21 Off-Centering

Own ship position, or sweep origin, can be displaced to expand the view field without switching to a larger range scale. On the R-type, the sweep origin can be off-centered to a point specified by the cursor, up to 100% of the range in use in any direction. On the IMO-type, the sweep origin can be off-centered to the cursor position, but not more than 75% of the range in use; if the cursor is set beyond 75% of the range scale, the sweep origin will be off-centered to the point of 75% of the limit.

This feature is not available on the longest range scale. The number of range rings increases keeping the original range intervals unchanged.

To off center the radar picture:

1. Place the cursor at a position where you wish to move the sweep origin by operating the trackball.

2. Press the OFF CENTER key. Then, the sweep origin is off-centered to the cursor position.
3. To cancel off-centering, press the OFF CENTER key again.

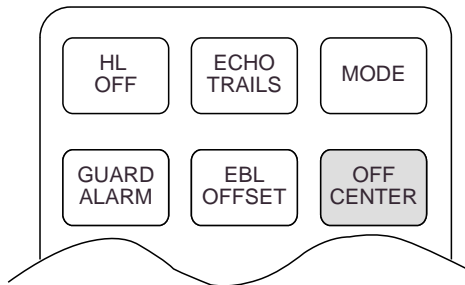

Inside mode panel

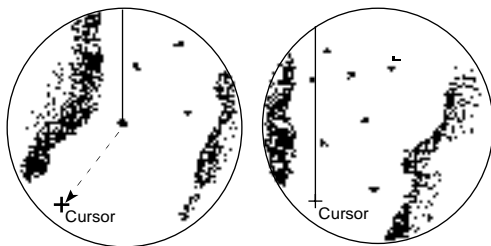

Off-centered to cursor position – Max. offset

100% of range in use on R-type  
75% of range in use on IMO-type

The picture cannot be off centered in the true motion mode.

## 1.22 Echo Stretch

On long ranges target echoes tend to shrink in the bearing direction, making them difficult to see. On short and medium ranges such as 1.5, 3 and 6 nm scales, the same size targets get smaller on screen as they approach the own ship. These are due to the inherent property of the radiation pattern produced by the antenna. To enhance target video, use the echo stretch function. There are two types: echo stretch 1 for long range detection and echo stretch 2 on 1.5-6 nm scales.

To activate the echo stretch:

1. Press the RADAR MENU key on the plotting keypad to show the FUNCTIONS menu.

2. Press the [2] key to select 2 ECHO STRETCH.
3. Press [2] until Echo Stretch option 1, 2 or OFF as desired is highlighted.
4. Press the ENTER key to conclude your selection followed by the RADAR MENU key to close the FUNCTIONS menu.

Hit [RADAR MENU].

[FUNCTIONS 1]	
1 PULSE WIDTH	1/2
2 ECHO STRETCH	OFF/1/2
3 ECHO AVERAGE	OFF/1/2/3
4 PANEL DIMMER	OFF/DIM/M/BRT
5 ECHO COLOR	YEL/GRN/COLOR*
6 SHIP'S SPEED	LOG/NAV*/MAN
7 INDEX LINES	NO.2 VRM/MAN
8 SET/DRIFT	OFF/MAN SET 000.0 DRIFT 00.0 KT
9 BRILLIANCE	
0 [SYSTEM SETTING 1]	

\* R-type only

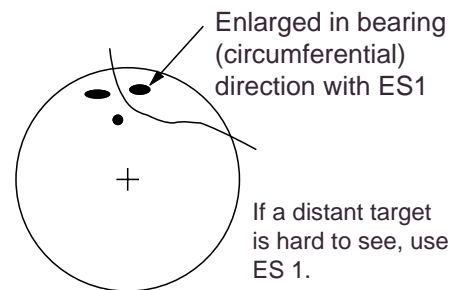

(a) Echo stretch 1 for 12 nm range and above

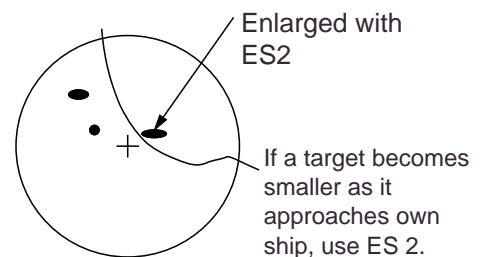

(b) Echo stretch 2 for 1.5–6 nm ranges

### Notes:

- 1) If the 1.5 nm range is preset for pulsewidth of S1 (0.08  $\mu$ s) or S2 (0.2  $\mu$ s), and the 3 nm scale for S2 (0.2  $\mu$ s), the echo stretch function is not available on these range scales.

2) The echo stretch function magnifies not only small target pips but also returns from sea surface, rain and radar interference. For this reason make sure these types of interference have been sufficiently suppressed before activating this function.

### 1.23 Echo Averaging

The echo average feature effectively suppresses sea clutter. Echoes received from stable targets such as ships appear on the screen at almost the same position every rotation of the antenna. On the other hand, unstable echoes such as sea clutter appear at random positions.

To distinguish real target echoes from sea clutter, this radar performs scan-to-scan correlation. Correlation is made by storing and averaging echo signals over successive picture frames. If an echo is solid and stable, it is presented in its normal intensity. Sea clutter is averaged over successive scans resulting in the reduced brilliance, making it easier to discriminate real targets from sea clutter.

To properly use the echo average function, it is recommended to first suppress sea clutter with the A/C SEA control and then do the following:

1. Press the RADAR MENU key on the plotting keypad to show the FUNCTIONS menu.

Hit [RADAR MENU].

[FUNCTIONS 1]	
1 PULSE WIDTH	1/2
2 ECHO STRETCH	OFF/1/2
3 ECHO AVERAGE	OFF/1/2/3
4 PANEL DIMMER	OFF/DIM/M/BRT
5 ECHO COLOR	YEL/GRN/COLOR*
6 SHIP'S SPEED	LOG/NAV*/MAN
7 INDEX LINES	NO.2 VRM/MAN
8 SET/DRIFT	OFF/MAN SET 000.0 DRIFT 00.0 KT
9 BRILLIANCE	
0 [SYSTEM SETTING 1]	

\* R-type only

2. Press the [3] key to select 3 ECHO STRETCH.

3. Press [3] until echo average option 1,

2 or OFF as desired is highlighted.

OFF: No averaging effect

1: Helps distinguish targets from sea clutter and suppresses brilliance of unstable echoes

2: Distinguishes small stationary targets such as navigation buoys.

3: Stably displays distant targets.

4. Press the ENTER key to conclude your selection followed by the RADAR MENU key to close the FUNCTIONS menu.

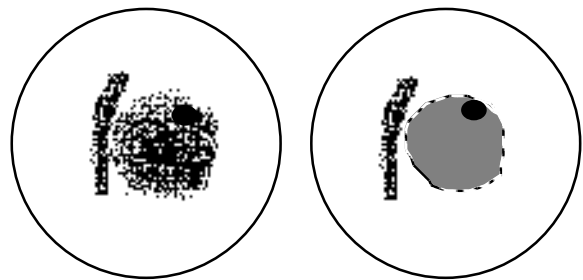

(a) Echo average OFF (b) Echo average ON

Echo averaging uses scan-to-scan signal correlation technique based on the true motion over the ground of each target. Thus, small stationary targets such as buoys will be shown while suppressing random echoes such as sea clutter. True echo average is not however effective for picking up small targets running at high speeds over the ground.

Echo average is inoperable when a gyro-compass signal is not available. If you wish to use this feature without a gyro-compass signal, consult a FURUNO representative.

Manual speed entry is done at menu item 6 SHIP'S SPEED on the FUNCTIONS menu which is accessed by pressing the RADAR MENU key.

## CAUTION

Do not use the Echo Average feature under heavy pitching and rolling; loss of true targets can result.

## 1.24 Electronic Plotting Aid (EPA)

A maximum 10 operator-selected targets can be plotted electronically (manually) to assess their motion trend. Five past positions can be displayed for each of the plotted targets. If you enter a 7th plot on a certain target, the oldest plot (past position) will be erased.

A vector appears when you enter a second plot for the target and is updated each time a new plot is entered. The vector shows the target motion trend based on its latest two plots.

Alphanumeric readouts at the upper right-hand corner of the screen show range, bearing, course, speed, CPA, TCPA, BCR and BCT of the last-plotted target.

It should be noted that the true course and true speed data are not updated in real time.

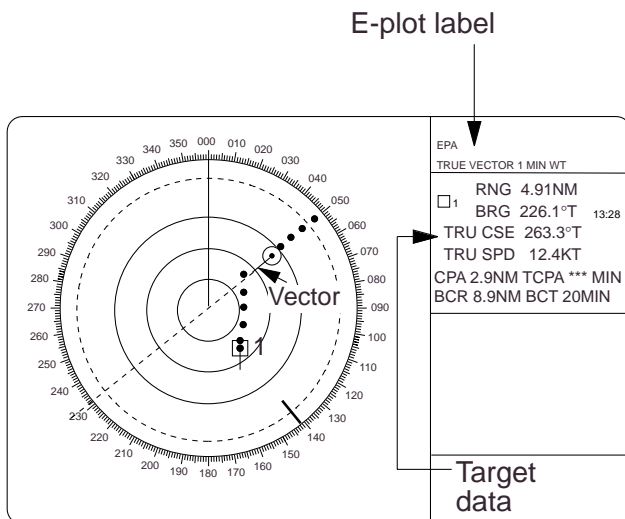

**Note:** EPA requires own speed input (automatic or manual) and a compass signal. The vector and data are updated on real time between plot entries. Note that the plots will be lost when the compass fails.

## Plotting a target

To perform electronic plotting:

1. Place the cursor(+) on a target of interest by operating the trackball.
2. Select a desired plot no. by pressing one of the plot no. keys on the plotting keypad.
3. Press the ACQ key on the operator control panel, and the selected plot no. is marked at the cursor position.
4. Watching the EPA time (TIM xx:xx) shown at the upper right margin of the screen, wait for at least 30 seconds. Place the cursor (+) on the target at its new location, select the same plot no. for the target and press the ACQ key.  
  
The plot no. moves to the new target position and previous position is marked by a small dot.
5. To acquire other targets, repeat the above steps selecting different plot no.

**Note:** If a target once plotted is not plotted again within 10 minutes, the warning "UPDATE PLOT No" will appear on the upper right margin of the screen and the plot no. of the target flashes. If you want to continue plotting this target, reacquire it within five minutes. Otherwise, the target will be regarded as a "lost target" and its plot no. and target data will be erased. The larger the plotting interval, the less accurate the plotted target data.

When a target has been plotted more than once, the radar calculates its motion trend and automatically displays a vector on the target.

If you make entry of plot at the unintentional position by mistake, re-enter the plot no. at the intentional position within five seconds. Then, a correction is accepted.



## True or relative vector

True vectors can be displayed with reference to the north. Press the VECTOR TRUE/REL key to select the proper indication. This feature is available in all presentation modes (gyrocompass must be working correctly). The current vector mode is indicated at the upper-right corner of the screen.

## Vector time

Vector time (or the length of vectors) can be set to 30 sec, 1, 2, 3, 6, 12, 15 or 30 minutes and the selected vector time is indicated at the upper-right corner of the screen. Press the VECTOR TIME key until the desired vector time is reached. The vector tip shows an estimated position of the target after the selected vector time elapses. It can be valuable to extend the vector length to evaluate the risk of collision with any target.

## Target data

The radar calculates motion trends (range, bearing, course, speed, CPA, TCPA, BCR and BCT) of all plotted targets.

In head-up and head-up true bearing modes, target bearing, course and speed shown in the upper-right target data field become true (suffix "TRU") or relative (suffix "REL") to own ship in accordance with relative vector setting. In north-up, course-up, and true motion modes, the target data field always displays true bearing, true course and speed over the ground.

## Reading the target data

Press the corresponding plot symbol key, and the following target data is displayed.

**RNG/BRG** (Range/Bearing): Range and bearing from own ship to last-plotted target with suffix "T" (True) or "R" (Relative) plot symbol.

**CSE/SPD** (Course/Speed): Course and speed are displayed for the last-plotted target with suffix "TRU" (True) or "REL" (Relative) plot symbol.

**CPA/TCPA**: CPA (Closest Point of Approach) is a closest range the target will approach to own ship. TCPA is the Time to CPA. Both CPA and TCPA are automatically calculated. TCPA is counted up to 99.9 min and beyond this, it is indicated as TCPA > \*99.9 MIN.

**BCR/BCT**: BCR (Bow Cross Range) is the range at which target will cross own ship's bow. BCT (Bow Cross Time) is the estimated time at which target will cross own ship's bow. If BCR is negative, BCR readout should be displayed as \*.\*. (When BCT is negative, BCT is x.x.)

## Terminating target plotting

With EPA you can plot up to 10 targets. You may wish to terminate plotting of less important targets to newly plot other threatening targets.

**By Symbol**: To terminate plotting of a certain target, press the corresponding plot no. key. Then press the CANCEL key.

**With Trackball**: Place the cursor (+) on a target which you do not want to be tracked any longer by operating the trackball and press the CANCEL key.

**All Targets**: To terminate plotting of all targets at once, press and hold the CANCEL key until all plot symbols and marks disappear in about 3 seconds.

## Entering own ship's speed

EPA requires an own ship speed input and compass signal. The speed can be entered from a speed log (automatic) or through the plotting keypad (manual).

## Automatic speed input

1. Press the RADAR MENU key on the plotting keypad to show the FUNCTIONS menu.

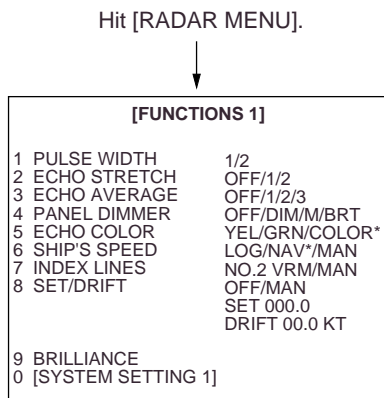

\* R-type only

2. Press the [6] key to select menu item 6 SHIP'S SPEED.
3. Press the [6] key to select (or highlight) LOG option.
4. Press the ENTER key to confirm your selection followed by the RADAR MENU key to close the FUNCTIONS menu. The ship's speed readout at the screen top shows own ship's speed fed from the speed log preceded by the label "LOG."

### Notes:

- 1) IMO Resolution A.823(19) for ARPA recommends that a speed log to be interfaced with an ARPA should be capable of providing through-the-water speed data.
- 2) Be sure not to select LOG when a speed log is not connected. If the log signal is not provided, the ship's speed readout at the screen top will be blank.

## Manual speed input

If the radar is not interfaced with a speed log, or the speed log does not feed correct speed enter the ship's speed as follows:

1. Press the RADAR MENU key on plotting keypad to show the FUNCTIONS menu.

2. Press the [6] key to select menu 6 SHIP'S SPEED.
3. Press the [6] key to select (or highlight) MAN option.
4. Press the ENTER key to confirm selection. At this point, "MAN = XX. KT" appears at the bottom of FUNCTIONS menu.
5. Enter the ship speed by hitting corresponding numeric keys followed by the ENTER without omitting leading zeros, if any. A example, if the ship speed is 8 knots, [0] [8] [ENTER].
6. Press the RADAR MENU key to close FUNCTIONS menu. The ship speed read at the screen top shows own ship speed entered preceded by the label "MAN."

## 1.25 Target Trails (Echo Trails)

Echo trails are simulated afterglow of target echoes that represent their movements relative to own ship or true movements with respect to land in a single tone or gradual shading depending on the settings on the RADAR 1 menu.

### True or relative trails

You may display echo trails in true or relative motion. Relative trails show relative movements between targets and own ship. True motion trails require a gyrocompass signal and own ship speed input to cancel out own ship's movement and present true target movements in accordance with their over-the-ground speeds and courses. Refer to the automatic and manual speed input procedures for entering own ship's speed information.

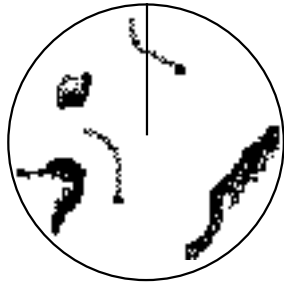

(a) True echo trails without smearing of stationary targets

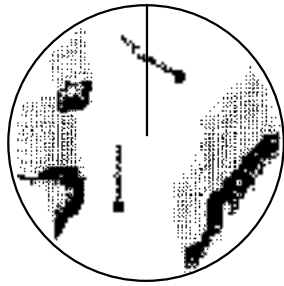

(b) Relative echo trails painted on all targets moving relative to own ship

**Note:** When true trail is selected on the RM mode, the legend TRUE TRAIL appears in red. No true-relative selection on TM, it is only TRUE TRAIL on TM mode.

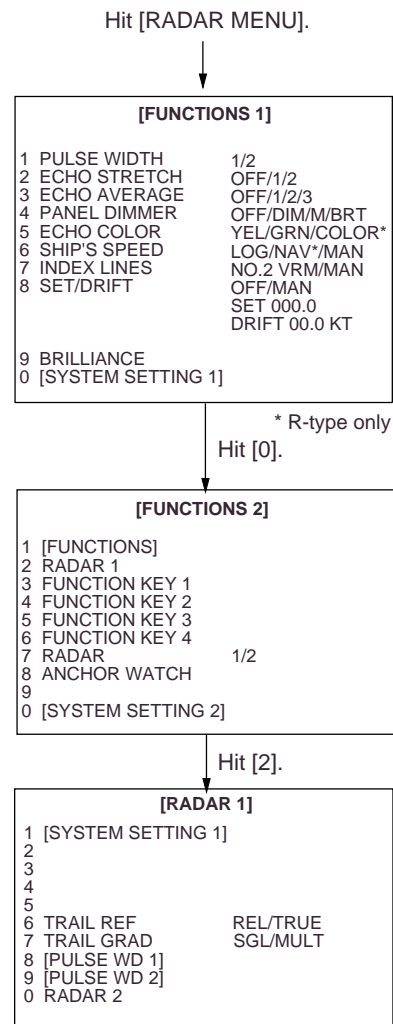

To select true or relative echo trail presentation:

1. Press the RADAR MENU key on the plotting keypad to show the FUNCTIONS menu.
2. Press the [0] key to show the SYSTEM SETTING 1 menu.
3. Press the [2] key to show the RADAR 1 menu.
4. Press the [6] key to select menu item 6 TRAIL REF.
5. Press the [6] key to select (or highlight) REL (Relative) or TRUE option.
6. Press the ENTER key to confirm your selection followed by the RADAR MENU key to close the menu.



## Trail gradation

Echo trails may be shown in monotone or gradual shading. Gradual shading paints the trails getting thinner with time just like the afterglow on an analog PPI radar.



*Monotone  
(Single)*



*Gradual shading  
(Multi)*

Selection of monochrome or gradual shading requires almost the same operation as for true or relative trails setup procedure described above except that you should:

- Press the [7] key to select menu item 7 TRAIL GRAD (graduation) in step 4.
- Press the [7] key to select (or highlight) SGL (single tone) or MULT (multiple shading) option in step 5.

## Displaying and erasing echo trails

Press the ECHO TRAILS key to activate or deactivate the echo trails feature.

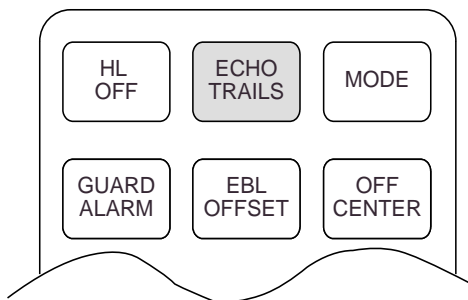

Each press of the ECHO TRAILS key within 5 seconds cyclically changes echo trail length (time) to 30 seconds, 1, 3, 6, 15 and 30 minutes, continuous echo trailing and OFF. The current echo trail setting is displayed at the lower-right corner of the screen.

OFF → 30 sec → 1 min → 3 min → 6 min

↳ Continuous ← 30 min ← 15 min ↲

Suppose that "3 MIN" has just been selected. If the ECHO TRAILS key is hit more than 5 seconds later, echo trails are removed from the display (memory still alive with echo trail timer count going on). Next hitting of the key calls out the echo trails on the screen. To proceed to longer plot intervals, successively push the ECHO TRAILS key with a hit-and-release action. The larger the echo trail length, the larger the echo trail plot interval.

**Note:** Holding the ECHO TRAILS key depressed for about 3 seconds will cause a loss of echo trail data so far stored in an in memory.

## Resetting echo trails

To reset (or clear) the echo trail memory, hold the ECHO TRAILS key depressed for about 3 seconds. Echo trails are cleared and the trailing process restarts from time count zero at current echo trail plot interval. When memory assigned to echo trailing becomes the echo trail timer at the lower-right corner of the screen freezes and the oldest trails are erased to show the latest trails.

## 1.26 Parallel Index Lines

Parallel index lines are useful for keeping a constant distance between own ship and a coastline or a partner ship when navigating. Index lines are drawn in parallel with the No.2 EBL (No.2 EBL must be active). The orientation of the index lines is controlled with the EBL control and the intervals between the lines adjusted with the VRM rotary control (provided that No.2 VRM is active).

Maximum number of the index line can be set the Initial Setting menu: 2, 3 or 6.

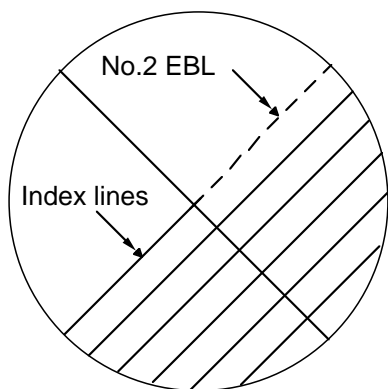

## Displaying and erasing the index lines

1. Press the INDEX LINES key if the index lines are not already shown.
2. Make sure that the No.2 EBL is active and orient the index lines in a desired direction with the EBL rotary control.
3. To erase the index lines, press the INDEX LINES key again.

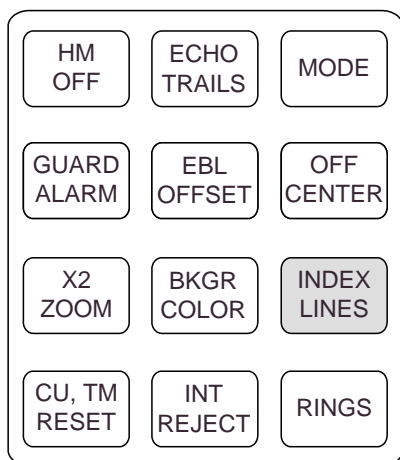

*Inside mode panel*

## Adjusting index line intervals

1. Press the RADAR MENU key on the plotting keypad to show the FUNCTIONS menu.

Hit [RADAR MENU].

[FUNCTIONS 1]	
1 PULSE WIDTH	1/2
2 ECHO STRETCH	OFF/1/2
3 ECHO AVERAGE	OFF/1/2/3
4 PANEL DIMMER	OFF/DIM/M/BRT
5 ECHO COLOR	YEL/GRN/COLOR*
6 SHIP'S SPEED	LOG/NAV*/MAN
7 INDEX LINES	NO.2 VRM/MAN
8 SET/DRIFT	OFF/MAN SET 000.0 DRIFT 00.0 KT
9 BRILLIANCE	
0 [SYSTEM SETTING 1]	

\* R-type only

2. Press the [7] key to select menu item 7 INDEX LINES.
3. Press the [7] key to select (or highlight) No.2 VRM or MAN (manual) option.
4. Press the ENTER key to conclude your selection.
5. If you have selected MAN in step 3 above, "MAN = XX.XX NM" appears at the bottom of the FUNCTIONS menu. Enter a desired line interval by hitting numeric keys followed by the ENTER key without omitting leading zeroes, if any. There are six index lines but the number of lines visible on the screen may be less than six depending on the line setting interval.
6. If you have selected NO.2 VRM in step 3 above, make sure that the No.2 VRM is active and adjust the spacing between the index lines by operating the VRM control.
7. Press the RADAR MENU key to close the FUNCTIONS menu.

## 1.27 Anchor Watch

The anchor watch feature helps you monitor whether own ship is dragged by wind and/or tide while at anchor. This feature requires ship position data from a suitable radio navigational aid. Provided that own ship's physical data has been entered, an own ship mark can be displayed when the anchor watch feature is activated. The message "ANCHOR WATCH ERR" appears in red when position data is not inputted.

### Notes:

- 1) The own ship mark is available on the R-type radar only; unavailable on the IMO type.
- 2) The own ship mark is created with data on ship's length, width, radar antenna location, etc. To display an own ship mark, ask your nearest FURUNO representative or dealer.

### Anchor watch in standby or transmit status

#### IMO-type

On the IMO type the anchor watch feature is available only in STANDBY status.

#### R-type

On the R-type the anchor watch feature is available in either STANDBY or TRANSMIT status.

### Activating anchor watch

To set up the anchor watch feature:

1. On the ANCHOR WATCH menu, press the [2] key to select menu item 2 ANCHOR WATCH OFF/ON.
2. Further press the [2] key to select (or highlight) ON, followed by the ENTER key to conclude your selection. The label WATCH appears at the lower-left corner of the screen.

3. Press the [3] key to select menu item 3 ALARM OFF/ON. Further press the [3] key to select (or highlight) ON or OFF, followed by the ENTER key to conclude your selection. (This operation determines whether to activate the anchor watch audible alarm.)

### Alarm range setting

Press the [4] key to select menu item 4 ALARM RANGE on the ANCHOR WATCH menu. Enter a desired alarm range between 0.1 and 9.999 nm with numeric keys and press the ENTER key to conclude your key input.

An anchor watch alarm circle thus established shows up as a red circle on the screen. When own ship is dragged out of this alarm circle, an audible alarm is generated and the on-screen label ANCHOR WATCH turns red.

To silence the audible alarm, press the AUDIO OFF key on the control panel.

Hit [RADAR MENU].

[FUNCTIONS 1]	
1	PULSE WIDTH 1/2
2	ECHO STRETCH OFF/1/2
3	ECHO AVERAGE OFF/1/2/3
4	PANEL DIMMER OFF/DIM/M/BRT
5	ECHO COLOR YEL/GRN/COLOR*
6	SHIP'S SPEED LOG/NAV*/MAN
7	INDEX LINES NO.2 VRM/MAN
8	SET/DRIFT OFF/MAN SET 000.0 DRIFT 00.0 KT
9	BRILLIANCE
0	[SYSTEM SETTING 1]

\* R-type only  
Hit [0].

[SYSTEM SETTING 1]	
1	[FUNCTIONS]
2	RADAR 1
3	FUNCTION KEY 1
4	FUNCTION KEY 2
5	FUNCTION KEY 3
6	FUNCTION KEY 4
7	RADAR 1/2
8	ANCHOR WATCH
9	
0	[SYSTEM SETTING 2]

Hit [9].

[ANCHOR WATCH]	
1	[SYSTEM SETTING 1]
2	ANCHOR WATCH OFF/ON
3	ALARM OFF/ON
4	ALARM RANGE 0.000 NM
5	HISTORY OFF/ON

## Showing drag line

Press the [5] key to select menu item 5 HISTORY on the ANCHOR WATCH menu. Further press the [5] key to select (or highlight) ON, followed by the ENTER key to conclude your selection.

A drag line, or a series of dots along which own ship was carried by wind and water current, appears as illustrated below. During the first 50-minute period, dots or own ship's past positions are plotted every minute. When 50 dots have been plotted in 50 minutes, the plot interval becomes 2 minutes and up to 25 dots are plotted during the succeeding 50-minute period. Next, the dot interval becomes 4 minutes and the maximum number of dots will be 12.

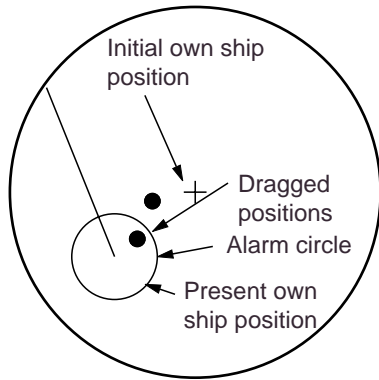

(a) Anchor watch in true motion mode

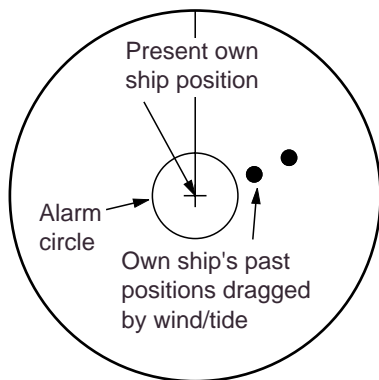

(b) Anchor watch in head-up mode

## 1.28 Origin Mark

You can mark any dangerous point, prominent target or a particular reference point using the origin mark feature. This mark is geographically fixed.

To use the origin mark:

1. Place the cursor (+) at a point where you want to place a reference mark by operating the trackball.
2. Press the ORIGIN MARK key on the plotting keypad. The origin mark appears at the cursor position of which range and bearing are indicated at the lower-left section of the screen.
3. To measure the range and bearing to a target of interest from the origin mark, move the cursor to the target of interest. Then, the range and bearing from the origin mark to the target are shown at the target data display.
4. To erase the origin mark, press the ORIGIN MARK key once again.

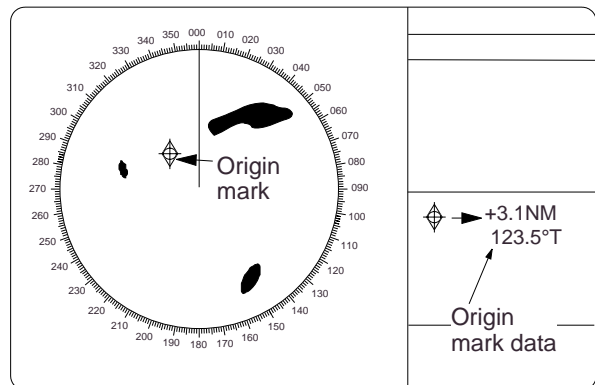
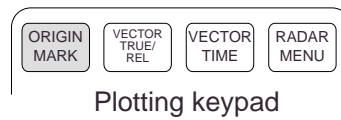

## 1.29 Zoom

The zoom function is available on the R-type radar only to enlarge an area of interest.

1. Place the cursor (+) close to the point of interest by operating the trackball.
2. Press the X2 ZOOM key. The area around the cursor and own ship is enlarged twice as large as the original size and the label ZOOM appears at the lower-left corner of the screen.
3. To cancel zoom, press the X2 ZOOM key again.

**Note:** The zoom feature is inoperative when the display is off centered.

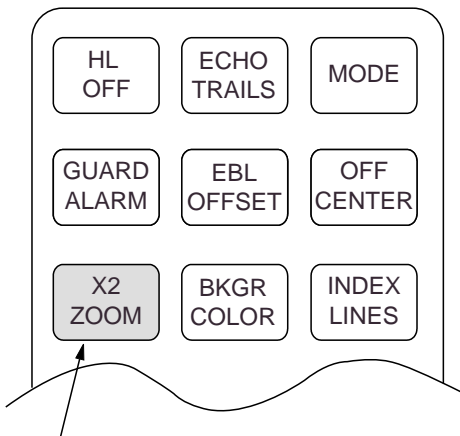

*ZOOM key is available on R-type only.  
Blank key top on N- and G-types.*

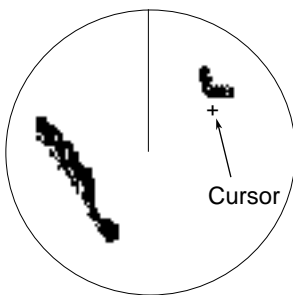

*(a) Cursor placed at point of interest*

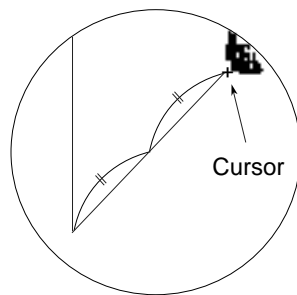

*(b) Zoom in (R-type only)*

## 1.30 Markers

### Heading marker

The heading marker indicates the ship's heading in all presentation modes. It ap-

pears at zero degrees on the bearing scale in head-up mode, in any direction depending on the ship orientation in north-up and true motion modes.

### Temporarily erasing heading marker

To temporarily extinguish the heading marker to look at targets existing dead ahead of own ship, press the HM OFF key on the mode panel. The heading marker reappears when the key is released.

### North marker

The north marker appears as a short dashed line. In the head-up mode, the north marker moves around the bearing scale in accordance with the compass signal.

### Stern marker

The stern marker (a dot-and-dash line) appears opposite to the heading marker. This marker can be displayed on the R-type only provided that STERN MARK ON is selected on the RADAR 2 menu.

## 1.31 Menu Keys

Three menu keys are provided on the plotting keypad: RADAR MENU, E-AUTO PLOT MENU and NAV MENU keys.

**RADAR MENU:** Permits setting of basic radar parameters.

**E, AUTO PLOT MENU:** Provides a choice of standard or large size of plotting symbols for plot.

**NAV MENU:** Provides a choice of navigation data for on-screen display. Also selects display data for the Video Plotter.

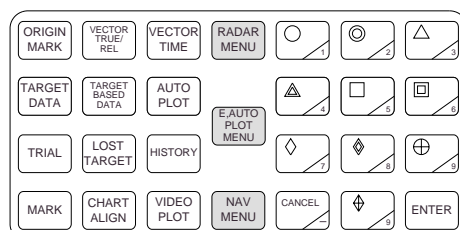

## 1.32 RADAR 1 and 2 Menu Settings

### R-type

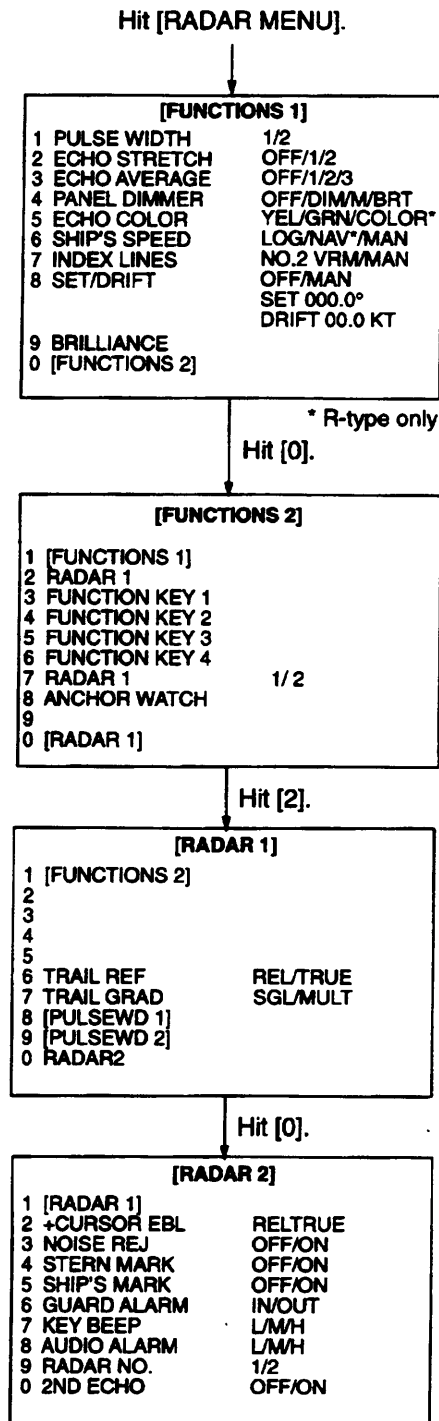

#### [FUNCTIONS 1] menu

5 ECHO COLOR: Targets are painted in monochrome yellow, green or full colors (red, yellow and green according to echo strengths).

#### [FUNCTIONS 2] menu

6 RADAR: Select 1 for single radar installation or for connecting to antenna unit No.1 on a dual radar installation; 2 for connecting to antenna unit No.2 on a dual radar installation.

#### [RADAR 1] menu

6 TRAIL REF: Select REL to show relative trails; TRUE to show true echo trails.

7 TRAIL GRAD: Select SGL to show echo trails in single tone; MULT to show them in multiple shading.

#### [RADAR 2] menu

2 CURSOR EBL: Select REL to read relative bearing of the cursor and EBL; TRUE to read true bearing of them.

3 NOISE REJ: Select ON to activate noise rejector; OFF to deactivate it.

4 STERN MARK: Select ON to show stern marker; OFF to hide it.

5 SHIP'S MARK: Select ON to show own ship's marker; OFF to hide it.

6 GUARD ALARM: Select IN for inward guard zone alarm; OUT for outward guard zone alarm.

7 KEY BEEP: Select sound level of key beep from L (low), M (medium), and H (high).

8 AUDIO ALARM: Select sound level of key beep from L (low), M (medium), and H (high).

9 RADAR NO.: Designate Radar No.1 or 2 on a dual radar installation. Select 1 on a single radar installation. (Note: Do not change the original setting. Consult a FURUNO representative or dealer for details.)

# IMO-type radar

## IMO-type radar

Hit [RADAR MENU].

[FUNCTIONS 1]	
1 PULSE WIDTH	1/2
2 ECHO STRETCH	OFF/1/2
3 ECHO AVERAGE	OFF/1/2/3
4 PANEL DIMMER	OFF/DIM/M/BRT
5 ECHO COLOR	YEL/GRN
6 SHIP'S SPEED	LOG/MAN
7 INDEX LINES	NO.2 VRM/MAN
8 SET/DRIFT	OFF/MAN SET 000.0° DRIFT 00.0 KT
9 BRILLIANCE	
0 [FUNCTIONS 2]	

### [FUNCTIONS 1] menu

5 ECHO COLOR: Targets are painted in monochrome yellow or green as selected.

Hit [0].

[FUNCTIONS 2]	
1 [FUNCTIONS 1]	
2 RADAR 1	
3 FUNCTION KEY 1	
4 FUNCTION KEY 2	
5 FUNCTION KEY 3	
6 FUNCTION KEY 4	
8 ANCHOR WATCH	
9	
0 [RADAR 1]	

Hit [2].

[RADAR 1]	
1 [FUNCTIONS 2]	
2	
3	
4	
5	
6 TRAIL REF	REL/TRUE
7 TRAIL GRAD	SGL/MULT
8 [PULSE WD 1]	
9 [PULSE WD 2]	
0 RADAR2	

### [RADAR 1] menu

6 TRAIL REF: Select REL to show relative trails; TRUE to show true echo trails.

7 TRAIL GRAD: Select SGL to show echo trails in single tone; MULT to show them in multiple shading.

Hit [0].

[RADAR 2]	
1 [RADAR 1]	
2 +CURSOR EBL	REL/TRUE
3 NOISE REJ	OFF/ON
4	
5 SHIP'S MARK	OFF/ON
6	
7	
8 AUDIO ALARM	L/M/H
9	
0 2ND ECHO	OFF/ON

### [RADAR 2] menu

2 CURSOR EBL: Select REL to read relative bearing of the cursor and EBL; TRUE to read true bearing of them.

3 NOISE REJ: Select ON to activate noise rejector; OFF to deactivate it.

5 SHIP'S MARK: Select ON to show own ship's marker OFF to hide it.

8 AUDIO ALARM: Select sound level of key beep from L (low), M (medium), and H (high).



### 1.33 Function Keys

The four function keys (#1-4) on the control panel work like the auto-dialing feature of a telephone, instantly calling out desired settings to perform specially assigned functions. The function keys provide optimum radar settings for a specific purpose with a single key operation.

Each function key can be assigned a combination of particular radar settings that will be most suited to your specific navigating purpose, and an adhesive label (such as BUOY, HARBOR, COAST or the like) is usually attached to the key top for easy identification of the assigned purpose.

The individual function keys are preset, or programmed, for the following purposes by qualified service personnel at the time of installation using the procedures described in the succeeding paragraphs:

Function key #1: Picture setup

Function keys #2 and #3: Picture setup and specific operation

Function key #4: Specific operation or watch alarm

Suppose that you have been navigating along a coast for hours and now you are approaching a harbor, your final destination. You will have to adjust your radar to change from the settings for coastal navigation to those for harbor approach. Every time your navigating environment or task changes, you must adjust the radar, which can be a nuisance in a busy situation. Instead of changing radar settings case by case, it is possible to assign the function keys to provide optimum settings for often encountered situations.

The radar's internal computer offers several picture setup options to be assigned to each function key for your specific navigating requirements. For instance, one of the function keys may be assigned the buoy detecting function and labeled BUOY on the key top. If you press this key, the radar will be instantly set for optimum detection of navigation buoys and similar objects and the label BUOY is shown at the left margin of the screen. If you re-press the same key, the radar returns to the previous settings.

#### Picture setup

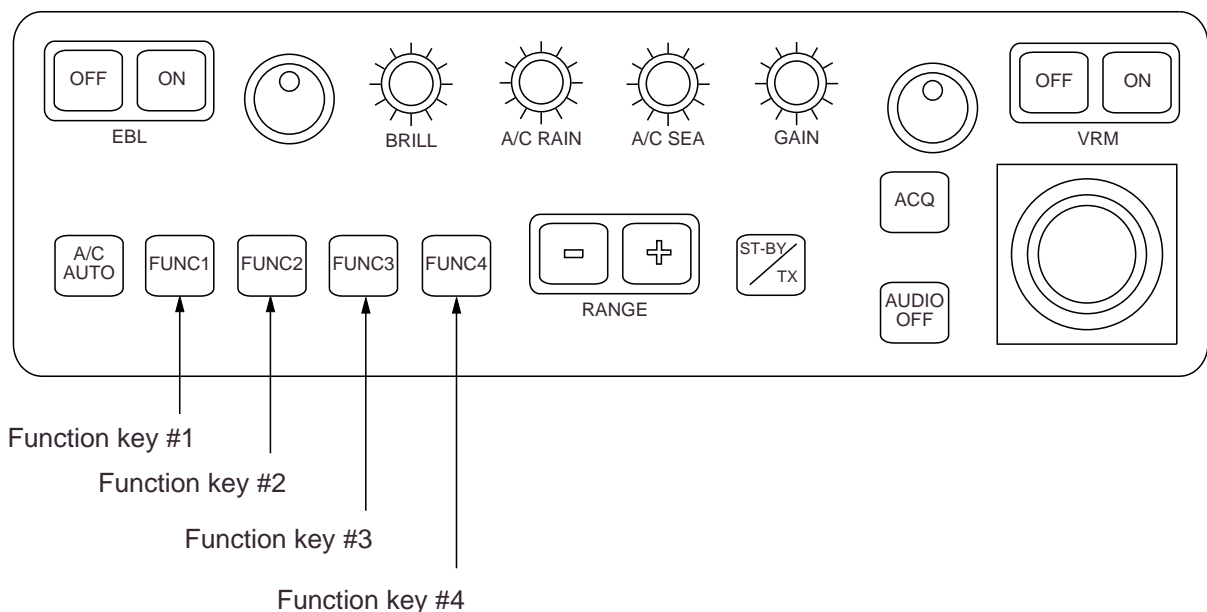



The picture setup options assignable to any of the function keys are shown in the table below.

Picture setup options for function keys

Label	Description
RIVER	Optimum setting for navigation on a river.
BUOY	Optimum setting for detecting navigation buoys, small vessels and other small surface objects.
SHIP	Optimum setting for detecting vessels.
SHORT	Optimum setting for short range detection using a range scale of 6 nm or larger.
CRUISING	For cruising using a range scale of 1.5 nm or larger.
HARBOR	Optimum setting for short range navigation in a harbor area using a range scale of 1.5 nm or less.
COAST	For coastal navigation using a range of 12 nm or less.
OCEAN	Transoceanic voyage using a range scale of 12 nm or larger.
ROUGH SEA	Optimum setting for rough weather or heavy rain.

Each picture setup option defines a combination of several radar settings for achieving optimum setup for a particular navigating situation. Those involved are interference rejector, echo stretch, echo average, automatic anti-clutter, pulsewidth and noise rejector settings.

Adjusting these features on a function key menu changes the original function key settings. To restore the original settings for a particular function key, it is necessary to display the relevant function key menu and select appropriate menu options.

**Note:** Function key presetting requires a good knowledge of optimum radar settings. If you want to change the original function key settings, consult your nearest FURUNO representative or dealer.

### Specific operation

Most often used controls are placed on the center panel while less often used controls are provided inside the covered compartments on the right and left sides. To avoid opening the covers or menus to set up the radar for a particular situation, function keys #2, #3 and #4 may be assigned a combination of the following settings at the time of installation.

- Head-up, Course-up, North-up or True Motion (See paragraph 1.9.)
- Echo trails (See paragraph 1.25.)
- Course-up and True Motion reset function (See paragraph 1.9.)
- Off-centering (See paragraph 1. 21.)
- Echo stretch 1 or 2 (See paragraph 1.22.)
- Pulsewidth 1 or 2 (See paragraph 1.11.)
- Echo averaging 1, 2 or 3 (See paragraph 1 .23.)
- Echo color (See paragraph 1.32.)
- Echo trail graduation (See paragraph 1.23.)
- Panel illumination
- Label brilliance
- Noise rejection

Provided that the function key is assigned the specific operation feature, press the key to instantly set the radar for the pre-set purpose. The corresponding label will be displayed at the left margin of the screen. If you re-press the function key, the radar returns to the previous settings.

**Note:** Function key presetting requires a good knowledge of optimum radar settings. If you want to change the original function key settings, consult your nearest FURUNO representative or dealer.

## Watch alarm

The watch alarm sounds an external buzzer selected time intervals to help you keep regular watch of the radar picture for safety or other purposes. This feature can be assigned to function key #4 with a choice of alarm intervals of 3, 6, 10, 12, 15 and 20 minutes. (See the flowchart on page 1-39 for keystroke sequence.)

Provided that function key #4 is assigned the watch alarm feature, just press function key #4 to activate the feature. The label WATCH appears at the lower-left corner of the screen associated with a watch alarm timer counts down from the initial value (namely, "12:00").

When an audible watch alarm is released the preset time interval has elapsed, the screen label WATCH turns red and the watch alarm timer freezes at "0:00."

To silence the alarm, press the AUDIO key. The label WATCH turns to normal color and the watch alarm timer is reset to the initial value and starts the count-down sequence again.

If you press the AUDIO OFF key before the selected time interval is reached, the watch alarm timer is reset to the initial value and starts the count-down sequence again.

# Setting for function key #1

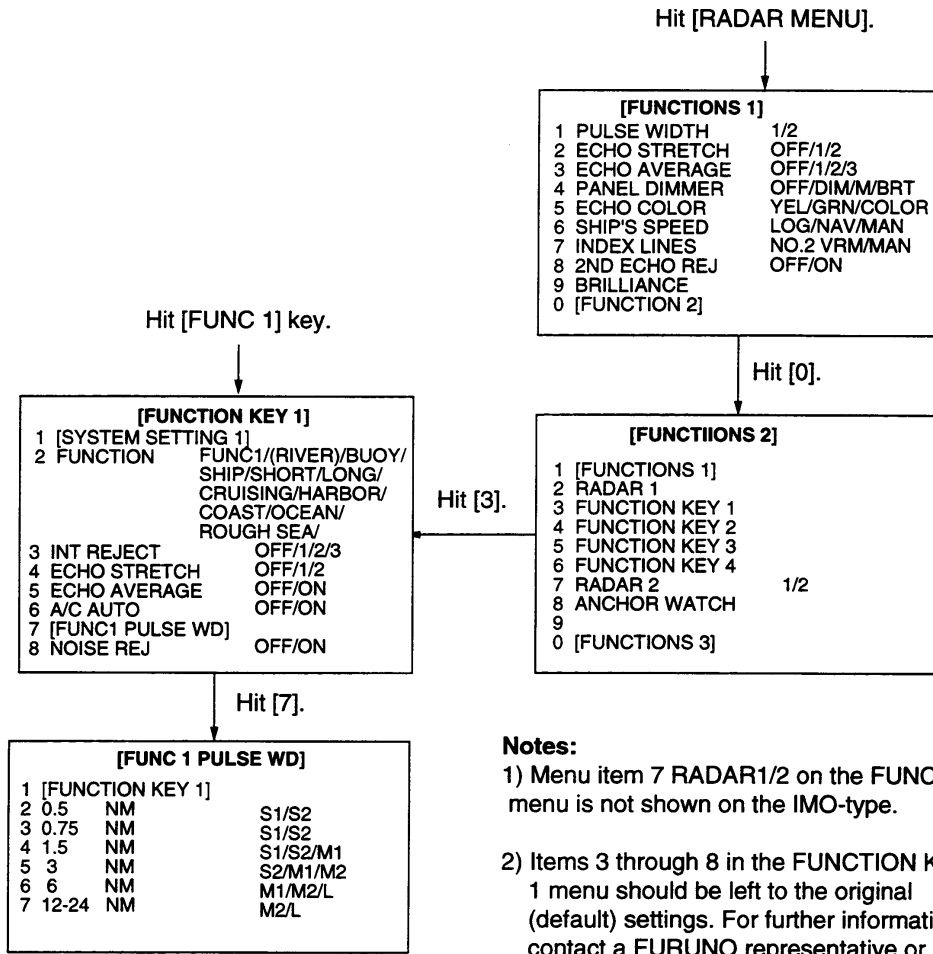

**Notes:**

- 1) Menu item 7 RADAR1/2 on the FUNCTIONS 2 menu is not shown on the IMO-type.
- 2) Items 3 through 8 in the FUNCTION KEY 1 menu should be left to the original (default) settings. For further information contact a FURUNO representative or dealer.

## Picture Setup Default for Function Keys 1, 2 and 3

To restore default settings, select appropriate function again and close the menu.

	3. INT REJ	4. E. S.	5. E. A.	6. A/C AUTO	8. NOISE REJ	0.5NM	0.75NM	1.5NM	3 NM	6NM	12-24NM
RIVER	2	1	OFF	OFF	OFF	S	S1	S1	S2	M1	M2
BUOY	3	2	3	OFF	ON	S1	S2	S2	M1	M2	L
SHIP	3	2	3	OFF	ON	S1	S2	S2	M1	M2	L
SHORT	2	OFF	OFF	OFF	OFF	S1	S1	S1	S2	M1	M2
LONG	3	2	3	OFF	ON	S1	S1	S1	S2	M1	M2
CRUISING	3	3	3	OFF	ON	S2	S2	S2	M2	L	L
HARBOR	3	OFF	OFF	OFF	OFF	S1	S1	S1	S2	M1	M2
COAST	2	OFF	OFF	OFF	OFF	S1	S1	S2	M1	L	L
OCEAN	2	OFF	3	OFF	OFF	S1	S2	S2	M1	M2	L
ROUGH SEA	2	OFF	2	ON	OFF	S1	S1	S2	M1	M2	L

## Setting for function key #2

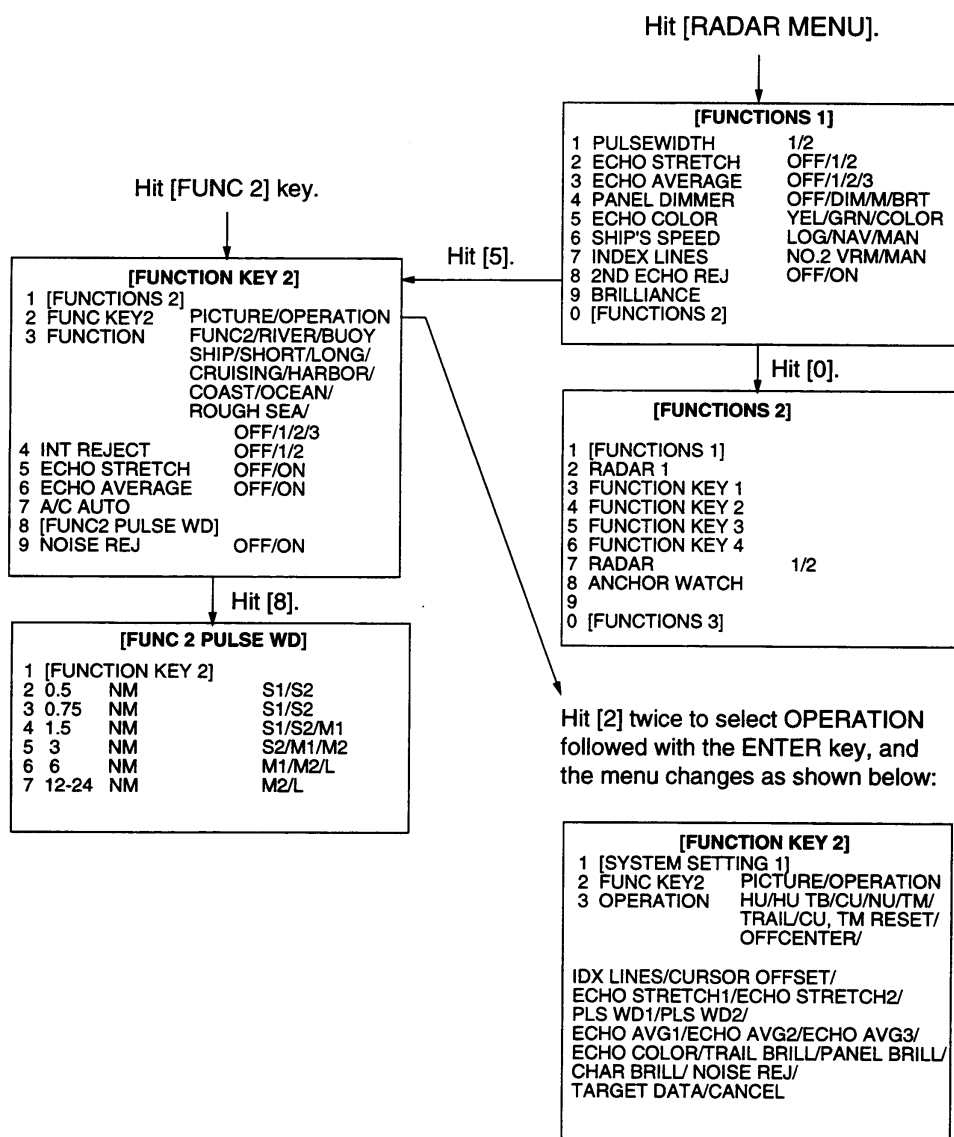

### Notes:

- 1) Menu item 7 RADAR 1/2 on the FUNCTIONS 2 menu is not shown on the IMO-type.
- 2) Items 4 through 9 on FUNCTION KEY 2 menu should be left in the default setting.  
For further information contact a FURUNO representative or dealer.

# Setting for function key #3

## Setting for function key #3

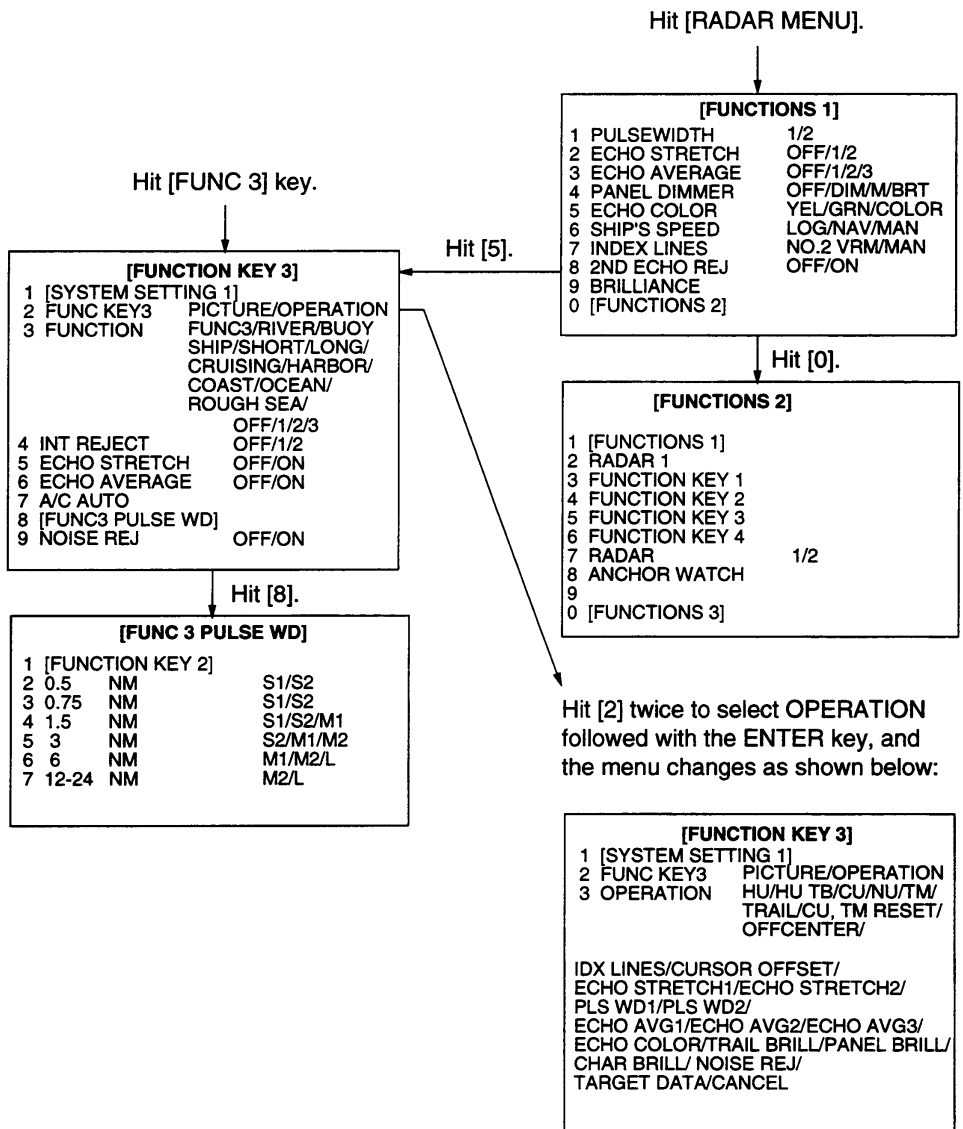

**Notes:**

- 1) Menu item 7 RADAR 1/2 on the FUNCTIONS 2 menu is not shown on the IMO-type.
- 2) Items 4 through 9 on FUNCTION KEY 3 menu should be left in the default setting.  
 For further information contact a FURUNO representative or dealer.

## Setting for function key #4

### Setting for function key #4

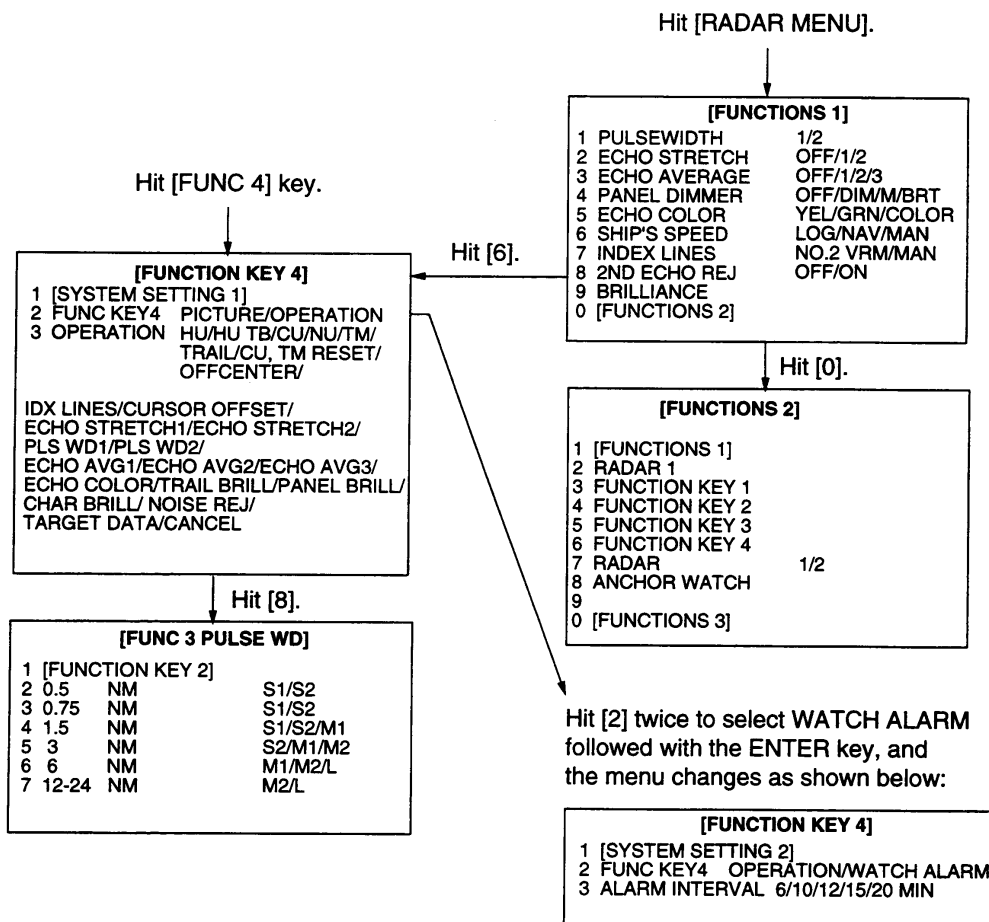

### 1.34 EPA Menu

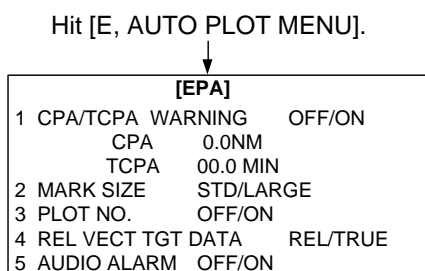

EPA menu appears by pressing the E, AUTO PLOT MENU key. You can set the following items.

1. COLLISION ALARM: You can set CPA and TCPA for the tracked target. Refer to 2.12 Setting CPA/TCPA Alarm range. Note that TCPA setting is available over one-minute.
2. MARK SIZE: Change the size of the plotting.
3. PLOT NO.: Displays or hides plot number at the right side of the plot symbol (circle and square). The selected target (square) has its number though PLOT NO. is OFF.
4. REL VECT TGT DATA: When the target vector is relative, select the target data mode REL(ative) or TRUE on HU and HUTB. For CU, NU and NUTM modes, the target data is always TRUE.
5. AUDIO ALARM: Select the audio alarm On or OFF for the target generating the collision alarm.

## 1.35 NAV INFORMATION Menu and Navigation Data Display

Various navigation data can be displayed on the radar screen. The data includes, depending on whether appropriate information is fed into the radar, own ship position, cursor position, waypoint data, wind data, water current data, depth data, water temperature, rudder angle, rate of turn and navigation lane.

Note that data not directly related with the radar presentation is not available. Shown below is a typical navigational data display.

1. Press the NAV MENU key on the plotting keypad to show the NAV INFORMATION menu.
2. Select navigation data input device and press the ENTER key to confirm your selection.
3. Also, set other nav data parameters as appropriate referring to the operation flow shown on the next page.
4. Press the NAV MENU key to close the NAV INFORMATION menu.

### Notes:

- 1) Own ship position display requires an input from an EPFS (electronics position-fixing system) such as a GPS receiver or a Loran-C receiver. Such an EPFS should be of the type which provides output data in accordance with IEC 61162.
- 2) When the sensor in use changes (ex. from GPS or DGPS), the name of sensor in the own ship call turns red, and EPFS label appears. To erase, press the CANCEL key.

### Displaying External Waypoint

The mark and data of external waypoint from an EPFS can be displayed by setting NAV LINE menu as follows. To display the menu, press [NAV MENU] [7] in order.

[WAYPOINT]	
1 [NAV INFORMATION 1]	
2 WPT	OFF/ON
4 WPT LINE	OFF/ON
5 WPT NO.	OFF/ON
8 ARRIVAL ALARM*	OFF/ON
	0.00 NM

**Note:** When the waypoint is more than 5000 nm, from own ship, the data reads ">5000 nm".

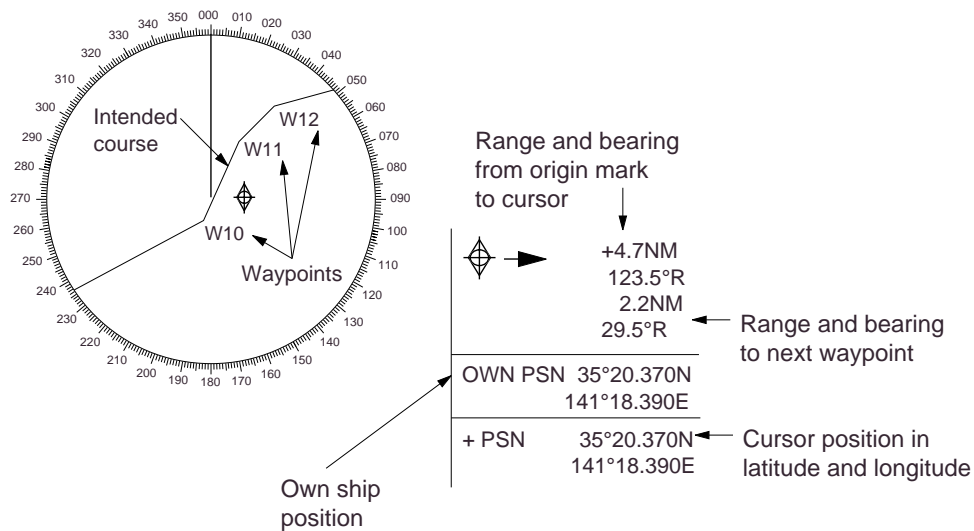

When WPL and RTE sentences are input, the following display appears by selecting NAV LINE ON.

When WPL and RTE sentences are input, the following display appears by selecting NAV LINE ON.

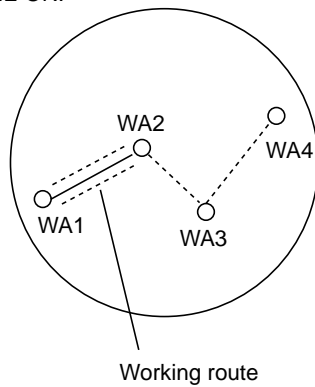



## 1.36 Radar Map

A radar map is combination of map lines and symbols whereby the user can define and input the navigation, route planning and monitoring data on the radar equipment. Map lines are navigational facility whereby the observer can define lines to indicate channels or traffic separation schemes. Also called nav lines, these line can be ground stabilized to stop them drifting. (Definition in Annex C of IEC 60936-1 and IEC 60872-1)

### Marking radar map

Select mark entry mode as follows.

1. Press the NAV MENU key to display the NAV INFORMATION 1 menu.
2. Press [1] key to display the RADAR MAP menu.

```
[RADAR MAP]
1 [NAV INFORMATION 1]
2 MAP
  OFF/ON
3 NAV DATA POSN
4 ALIGN +CURSOR
  OFF/ON
5 MARK ENTRY MODE
  CORSOR/L/L/OWN SHIP POSN
6 ERASE MARK
  OFF/AREA/ALL
```

3. Press [2] key to twice to select ON, and then press the ENTER key. MAP indication appears at the right-hand of the screen.
4. Press [5] key several times to select the entry mode, cursor, L/L or own ship position.
5. Press the ENTER key followed by the NAV MENU key.

A radar map contain 1500 points of mark and line data.

Mark a radar map as follows.

### By Cursor position;

1. Press the MARK key to display the ENTER MARK menu.

```
[ENTER MARK]
MARK 01
01.  △
02.  +++
03.  ☼
04.  ⚓
05.  □
06.  ○
07.  ·
08.  ×
09.  ∞
10.  □
11.  ↓
12.  ●
13.  ◇
14.  —
15.  —
16. NAV LINE
17. COAST LINE
18. CONTOUR LINE
19. PROHIBITED AREAS
20. CABLE
21. LINE CHANGE
22. MARK CANCEL*
```

\*The mark cancel may be used when the new line is entered at the other position after marking a line by using the same number mark.

2. Enter mark number to select desired mark, followed by the ENTER key.
3. Place + cursor an appropriate point.
4. Press the ENTER key.
5. Repeat steps 2 to 4 above. To enter the same mark selected at step 2, simply repeat step 3 and 4.
6. To escape the mark entry mode, press the MARK key.

### By L/L position entry mode

1. Press the MARK key to display the ENTER MARK menu. On L/L entry mode, the latitude and longitude are appears.

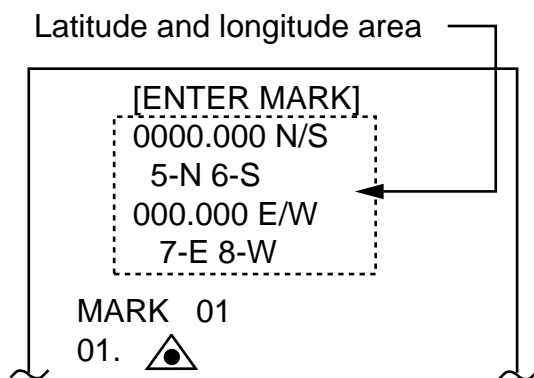

2. Key in the latitude. If necessary, press the following key.  
 [5] key; N, [6] key; S
3. Key in the longitude. If necessary, press the following key.  
 [7] key; E, [8] key; W
4. Select mark.
5. Press the ENTER key.

### By own ship position entry mode

1. Press the VIDEO PLOT key.
2. Press the MARK key.
3. Enter mark number.
4. Press the ENTER key.

**Note:** Waypoints used to make NAV lines, as described on page 1-40, can be erased on the NAV LINE menu.

### Chart alignment

You can align the chart data and radar image, by using the ALIGN key.

1. Press the ALIGN key.
2. Operate the trackball to align the chart on the radar.
3. Press the ALIGN key to fix.

### Other items

#### 3. NAV DATA POSN:

Reset the chart alignment.

#### 4. ALIGN + CURSOR

Select ON, plus the alignment rate to the cursor data which is appeared at the lower of the display.

#### 6. ERASE MARK

AREA; Erase all marks on the current appearing display.

ALL; Erase all marks in the CPU.

### 1.37 Suppressing Second-trace Echoes

In certain situations, echoes from very distant targets may appear as false echoes (second-trace echoes) on the screen. This occurs when the return echo is received one transmission cycle later, that is, after a next radar pulse has been transmitted.

To activate or deactivate the second-trace echo rejector:

1. Press the RADAR MENU key on the plotting keypad to show the FUNCTIONS menu.
2. Press the [8] key to select menu item 8 2ND ECHO REJ.
3. Further press the [8] key to activate (ON) or deactivate (OFF) the second-trace echo rejector.
4. Press the ENTER key to conclude selection followed by the RADAR MENU key to close the FUNCTIONS menu.

## 1.38 Adjusting Relative Brilliance Levels of Screen Data

You can adjust relative brilliance levels of various marks and alphanumeric readouts displayed on the screen by following the steps shown below:

1. Press the RADAR MENU key on the plotting keypad to show the FUNCTIONS menu.
2. Press the [9] key to show the BRILLIANCE menu.
3. Select a desired menu item by pressing the corresponding numeric key. As an example, press [4] if you want to change the brilliance of echo trails.
4. Further press the same numeric key as you pressed in step 3 above to select or highlight a desired brilliance level.
5. Press the ENTER key to conclude your selection followed by the RADAR MENU key to close the FUNCTIONS menu.

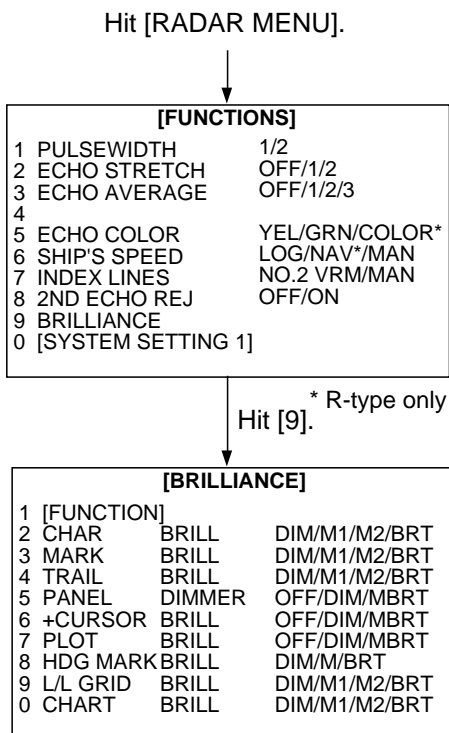

The table below describes which menu item adjusts the brilliance of which picture element.

Menu item	Of which brilliance is adjusted?
CHAR	Alphanumeric readouts
MARKS	Bearing scale, EBLs and VRMs
TRAILS	Echo trails
PANEL	Operator control panel
+CURSOR	Trackball cursor (+)
PLOT	Plot symbols and marks for E-plot and optional Auto Plotter ARP-25
HDG MARK	Heading line and stern marker (Stern marker displayed on R-type only.)
L/L GRID	Lat/long grid lines generated by optional Auto Plotter ARP-25
CHART	Chart generated by optional Auto Plotter ARP-25

**Note:** You should adjust the entire CRT brilliance by operating the BRILL control before adjusting relative brilliance levels on the BRILLIANCE menu.

## 1.39 Set and Drift (Set and Rate)

Set the direction in which a water current flos, can be manually entered in 0.1 - degree steps. Drift, in another word Rate, the speed of tide, can also be entered manually in 0.1 knot steps.

Set and drift corrections are benefcal for increasing the accuracy of vectors and target data. The correction is best made in the head-up mode with true vector, watching landmasses, or other stationary targets. If they have vectors, set and drift values should be adjusted until they lose vectors.

**Note:** Set and drift correction is available on selecting the water tracking mode only.

Proceed as follows to enter set and drift (rate):

1. Press the RADAR MENU key on the plotting keyboard to show the FUNCTIONS 1 menu.
2. Press the [8] key to select menu item 8; SET, DRIFT.
3. Further press the [8] key to select OFF or MAN option.

OFF: No correction against set and drift.

MAN: Manual entry of set and drift data.

4. If OFF is selected, press the ENTER key.
5. If you have selected MAN in step 3 above, the highlight cursor will advance one line down requesting you to enter SET xxx.x°. Enter the value of set in degrees by hitting numeric keys without omitting leading zeroes, if any, and press the ENTER key.

The highlight cursor will then advance to the next line DRIFT xx.x KT. Enter the value of drift in knots by hitting numeric keys without omitting leading zeroes, if any, and press the ENTER key. Set and drift have the same effect on own ship and all targets.

6. Press the RADAR MENU key to close the menu.

4. Do the same to indicate ocean current graph and echo-sounding chart. Depth scales can be selected among 10, 20, 50, 100, 200 and 500 m on the NAV INFORMATION 2 menu.

5. Press [0] key twice to show the NAV INFORMATION 3 menu.

6. Press [2] key twice and press ENTER key to select UTC.

**Note:** Wind data current data require the respective sensors. The depth data requires an adequate echo-sounding equipment. The echogram shows the last 30 minutes of depths along the ship's track. Wind vector shows a direction from which the wind blows in, relative to own ship heading, and labeled T\*. Wind velocity is a true wind speed as a result of compensating for own ship's speed and orientation. Ocean current (tide) is the direction to which the current is flowing away from own position, relative to north.

\*T in this case means a true value meanwhile T denotes "relative to True North" in the case of EBLs and target ship vectors.

## 1.40 Display of Ancillary Information

Wind and tide data and depth sounding data can be displayed in the text cell which is normally used to indicate third target ship data. Do as follow:

1. Press the NAV MENU key to show the NAV INFORMATION 1 menu.
2. Press [8] key twice to set WIND DATA ON and press the ENTER key.
3. Press [9] key twice to set WIND GRAPH ON and press the ENTER key.

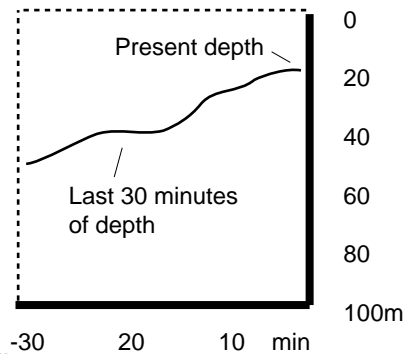
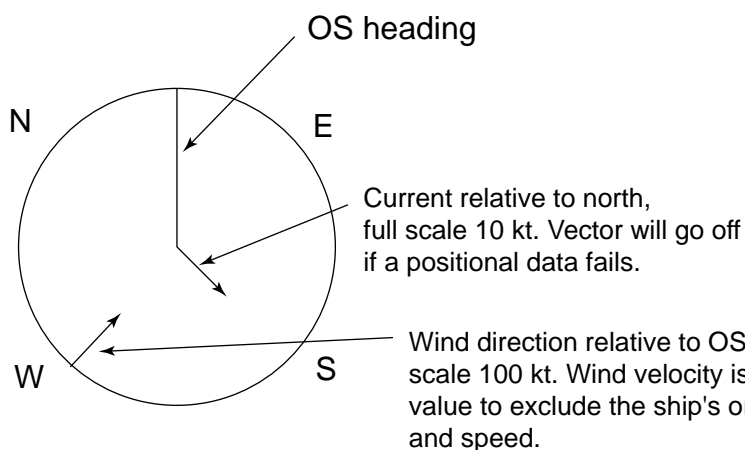

Example of Depth graph

Example of Head-up mode

## 1.41 Alarms

This radar generates visual and audible alarms to alert you to certain events or systems failures, to provide enhanced safety and convenience. The table below summarizes these alarms.

Problem	Audible alarm	Visual alarm	To quit alarm status
Gyro failure	2 beeps	HDG label reads ***.* and GYRO in red appears at the lower-right corner of the screen. Display is automatically switched to head-up mode within 1 min.	Change the presentation mode when the gyro input has been restored. Align the on-screen GYRO readout, if necessary. Then, press the CANCEL key to erase the message SET HEADING.
Target alarm (TAZ)	Beeps	Target flashes	Press the GUARD ALARM key to silence the alarm.
Watch alarm	Beeps	WATCH 0:00 (Label "WATCH" turns red and time count freezes at 0:00.)	Press the AUDIO OFF key to silence the alarm. The label WATCH turns to normal video and the timer is reset.
Own ship lat/lon, Cursor lat/lon	None	***.* in own ship position field ***.* in own cursor position field	Make sure that own ship position data is fed from external EPFS.
System failure	None	Message BRG SIGNAL MISSING shows at screen bottom. No radar echoes. SYSTEM FAILURE in red at the lower left of the display during Track Test.	Make sure the Antenna switch in the turning compartment is ON.
Incorrect Keystroke	Double beep tone (Key beep not available on IMO-type.)	None	Perform correct key operation. Correct keystroke is responded by a single beep tone provided that KEY BEEP ON is selected in initial settings.
LOG failure	2 beeps	LOG *.* and the label LOG turns red, if no log signal is input for 30 sec while the ship speed has been more than 5.0 kt.	If the SDME has field, use the Manual Speed mode or other appropriate sensor.
AZIMUTH HDG TRIG VIDEO	1 beeps 1 beeps 1 beeps 1 beeps	AZIMUTH in red HDG in red TRIG in red VIDEO in red	When input signal corners in.

# 2. OPERATION OF ARPA

## 2.1 General

The FAR-2805 series with ARP-25 board provide the full ARPA (Automatic Radar Plotting Aid) functions complying with IMO A. 823 as well as complying with the radar performance in MSC.64 (67) Annex 4.

This chapter describes the operation of the ARPA. For operation of normal radar, refer to Chapter 1.

### Principal specifications

#### Acquisition and tracking

- Automatic acquisition of up to 20 targets plus manual acquisition of 20 targets, or fully manual acquisition of 40 targets between 0.1 and 32 nm (0.1 and 24 nm depending on initial setting)
- Automatic tracking of all acquired targets between 0.1 and 32 nm (0.1 and 24 nm depending on initial setting)

#### Vectors

Vector length: 30 sec, 1, 2, 3, 6, 12, 15, 30 min.

Orientation: True velocity or relative velocity

Motion trend: Displayed within 20 scans, full accuracy within 60 scans after acquisition.

Past positions: Choice of 5 or 10 past positions at intervals of 30 sec, 1, 2, 3 or 6 min.

Alarms: Visual and audible alarms against targets violating CPA/TCPA limits, lost targets, targets crossing guard zone (guard ring), system failure and target full status.

Trial maneuver: Predicted situation appears in 1 min after selected delay (1-60 minutes).

## 2.2 Keys Used for ARPA

The Auto Plotter uses the keys on the plotting keypad on the right side of the radar screen and two keys on the control panel. Below is a brief description of these keys.

E-plot is inoperable in ARPA mode. For E-plot refer to section 1.24 and 1.34.

**CANCEL:** Terminates tracking of a single target specified by the trackball if the key is pressed with a hit-and-release action. If the key is held depressed for about 3 seconds, tracking of all targets is terminated.

**ENTER:** Registers menu options selected.

**VECTOR TRUE/REL:** Selects true or relative presentation of target vectors.

**VECTOR TIME:** Selects a vector length of 30 sec, 1, 2, 3, 6, 12, 15 or 30 min.

**TARGET DATA:** Displays data on one of tracked targets selected by the trackball.

**TARGET BASED SPEED:** Own ship's speed is measured relative to a fixed target.

**AUTO PLOT:** Activates and deactivates the ARPA functions.

**TRIAL:** Shows consequences of own ship's speed and course against all tracked targets.

**LOST TARGET:** Silences the lost target aural alarm and erases the lost target symbol.

**HISTORY:** Shows and erases past positions of tracked targets.

**ACQ** (on control panel): Manually acquires a target.

**AUDIO OFF** (on control panel): Silences aural alarm.

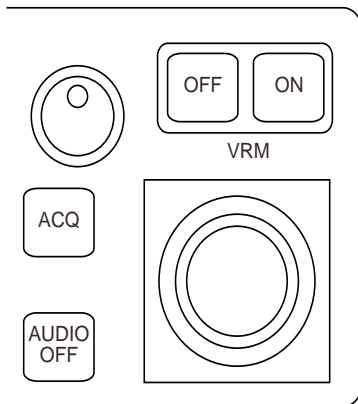

Control panel

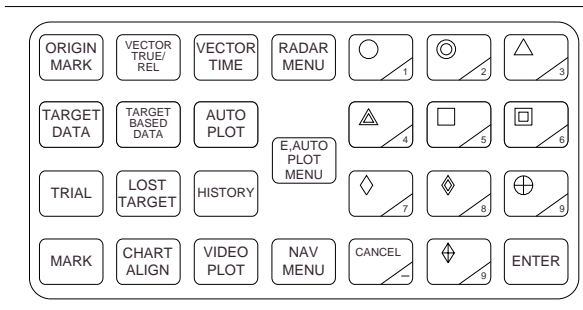

Plotting keypad

**CRITERIA OF TRACKING**  
 A target measuring 800 m or more in the radial or circumferential direction is regarded as a landmass and not acquired or tracked. Echoes smaller than 800 m are regarded as targets to be tracked.

## 2.3 ARPA Menu Operation

Various parameters for the Auto Plotter are set on the ARPA 1 and ARPA 2 menus. To do this, follow the steps shown below:

1. Press the AUTO PLOT key if the Auto Plotter is not yet activated. Note that the label ARPA appears in the upper-right box on the screen.
2. Press the E, AUTO PLOT MENU key to show the ARPA 1 menu.
3. Press the [0] key once if you wish to go to the ARPA 2 menu.

4. Select a desired menu item by pressing the corresponding numeric key.
5. Select a menu option by pressing the same numeric key as pressed in step 3 above. If there is more than one option on the current menu item, you may need to press the numeric key several times. Press it until the desired option is highlighted. (Note that certain menu items will prompt you to enter numeric data or to define points on the radar screen with the trackball.)
6. Press the ENTER key to register settings.
7. Press the E, AUTO PLOT MENU key to close the menu.

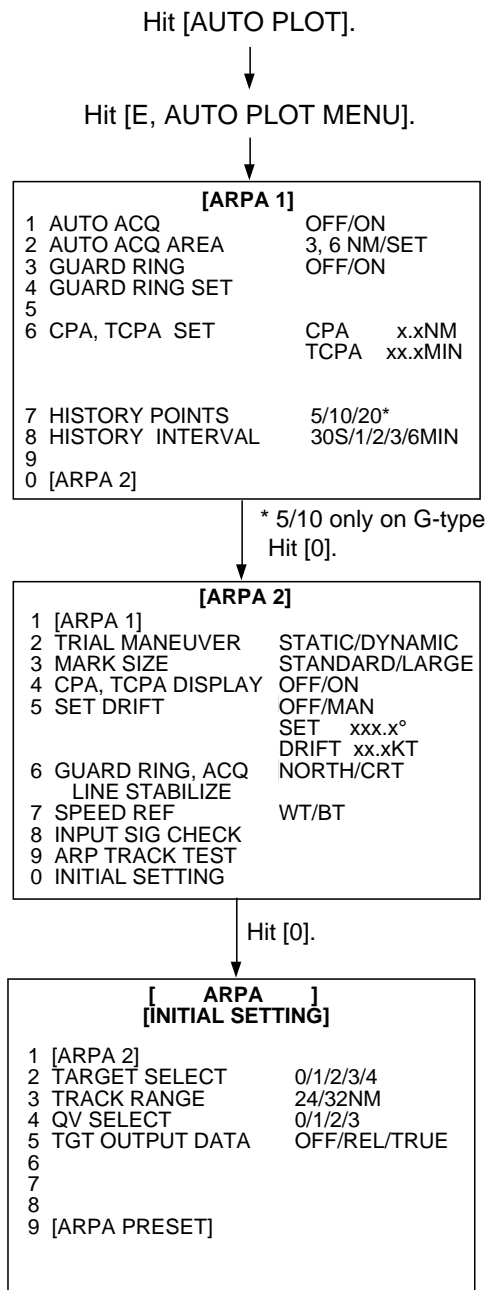

## 2.4 Start-up Procedure

### Activating the ARPA

To activate the ARPA:

1. Adjust the A/C RAIN, A/C SEA and GAIN controls for proper radar picture.
2. Press the AUTO PLOT key. The label ARPA appears in the box at the upper-right on the screen.

### Entering own ship's speed

The ARPA requires own ship's speed and heading data. Of these, the speed data can be entered automatically from a speed log, navaid, or manually through the numeric keys or based on a selected reference target (such as a buoy or other prominent stationary target).

### Automatic speed input

For speed log input:

1. Press the RADAR MENU key on the plotting keypad to show the FUNCTIONS menu.

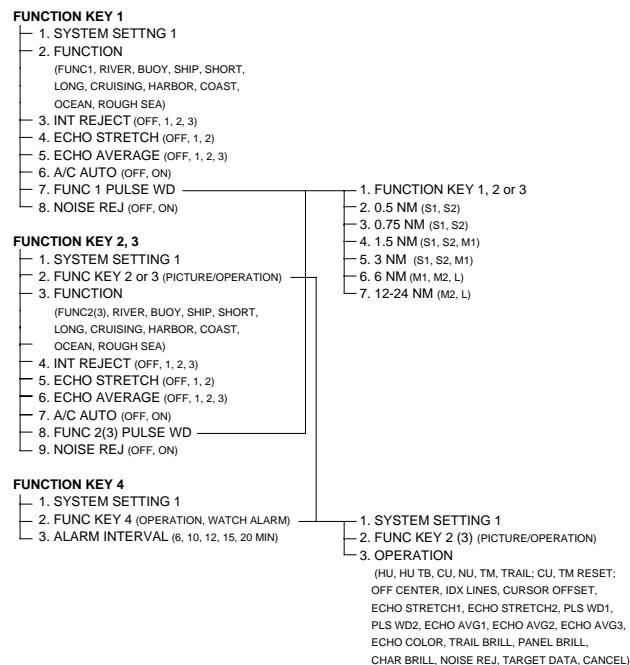

2. Press the [6] key to select menu item 6SHIP'S SPEED.
3. Press the [6] key to select (or highlight) LOG option.

4. Press the ENTER key to conclude your selection followed by the RADAR MENU key to close the FUNCTIONS menu. The ship's speed readout at the top of the screen shows own ship's speed fed from the speed log preceded by the label "LOG."
5. When the speed log is used, select speed reference to either of SEA or GND(ground) on the ARPA 2 menu.

### Notes:

- 1) IMO Resolution A.823:1995 for ARPA recommends that a speed log to be interfaced with an ARPA should be capable of providing through-the-water speed data rather than over-the-ground speed.
- 2) Be sure not to select LOG when a speed log is not connected. If the log signal is not provided, the ship speed readout at the top of the screen will be blank. In the event of a log error, you can continue plotting by entering a manual speed.
- 3) If a log signal interval becomes more than 30 seconds with the ship's speed 5KT or more, the radar regards the speed log is in a trouble and LOG FAIL appears, reading xx-x KT. For R-type, if no speed input is present for 3 minutes at below 0.1KT, the radar regards the log is in failure.

### Manual speed input

To manually enter the ship's speed with the numeric keys:

1. Press the RADAR MENU key on the plotting keypad to show the FUNCTIONS menu.
2. Press the key [6] to select menu item 6SHIP'S SPEED.
3. Press the key [6] to select (or highlight) MAN option.
4. Press the ENTER key to conclude your selection. At this point, "MAN = xx.x KT" appears at the bottom of the FUNCTIONS menu.



5. Enter the ship speed by hitting corresponding numeric keys followed by the ENTER key without omitting leading zeroes, if any. As an example, if the ship speed is 8 knots, press [0] [8] [ENTER]. For 4.5 knots, [0] [4] [5] [ENTER].
6. Press the RADAR MENU key to close the FUNCTIONS menu. The ship speed readout at the screen top shows own ship's speed you entered preceded by the label "MANU."

## Target-based speed

The use of target-based speed is recommended when:

- The speed log is not operating properly or not connected to the radar.
- The vessel has no device which can measure ship's leeward movement (doppler sonar, speed log, etc.) though leeward movement can not be disregarded.

If you select target-based speed, the Auto Plotter calculates own ship's speed relative to a fixed reference target.

**Note:** When the target-based speed is adopted, automatically or manually entered ship's speed is disregarded.

To establish target-based speed:

1. Select a small fixed island or any radar prominent point located at 0.2 to 24 nm from own ship.
2. Place the cursor (+) on the target by operating the trackball.
3. Press the TARGET BASED SPEED key.  
The reference target mark (see below) appears at the cursor position and the own ship data label changes from "LOG," "NAV" or "MANU" to "REF." Note that it takes one minute before a new speed is displayed.

 Reference target mark

## Notes:

- 1) When the reference target is lost or goes out of the acquisition range, the reference target mark blinks and the speed reads "xx.x." Select a different reference target in this case.
- 2) When all targets are deleted, the reference target mark is also deleted and the target-based speed becomes invalid. The speed is indicated in KTBT where BT means Bottom Track (speed over ground).
- 3) The vector of the reference target can be displayed by menu operation (Auto Plot 1 menu).

## Canceling target-based speed

To cancel the target-based speed, just press the TARGET BASED SPEED key. The speed is shown by LOG, NAV\* or MANUAL as selected previously. (NAV only on R-type)

## Deactivating the ARPA

To deactivate the ARPA, just press the AUTO PLOT key. Target plotting symbols and the on-screen label ARPA will disappear.

**Note:** Even when the ARPA is turned off, target tracking still goes on until the radar is turned off. (For G-type, target tracking goes off at STBY.)

## 2.5 Automatic Acquisition

The ARPA can acquire up to 40 targets (20 automatically and 20 manually or all 40 manually. If AUTO ACQ is selected after more than 20 targets have been manually acquired, only the remaining capacity of targets can be automatically acquired. For example, when 30 targets have been acquired manually, then the ARPA is switched to AUTO ACQ. Only 10 targets can be acquired automatically. A target just acquired automatically is marked with a broken square and a vector appears about

one minute after acquisition indicating the target's motion trend. Three minutes after acquisition, the initial tracking stage is finished and the target becomes ready for stable tracking. At this point, the broken square mark changes to a solid circle. (Targets automatically acquired are distinguished from those acquired manually, displayed by bold symbol.)

## Enabling and disabling auto acquisition

1. Press the E, AUTO PLOT key if the ARPA is not yet activated. Note that the label ARPA appears in the box at the upper-right on the screen.

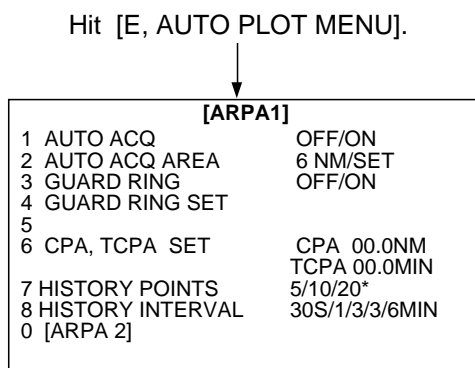

\*5/10 only on IMO-type

2. Press the E, AUTO PLOT MENU key to show the ARPA 1 menu.
3. Press the [1] key to select menu item 1AUTO ACQ.
4. Further press the [1] key to select (or highlight) ON (enable auto acquisition) or OFF (disable auto acquisition) as appropriate.
5. Press the ENTER key to conclude your selection followed by the E, AUTO PLOT MENU key to close the AUTO PLOT 1 menu. Note that the label AUTO+MAN is displayed in the box at the upper-right on the screen when auto acquisition is enabled; MAN when auto acquisition is disabled.

**Note:** When the ARPA has acquired 20 targets automatically, the message AUTO TARGET FULL is displayed in the box at the right-hand side of screen.

## Setting auto acquisition areas

Instead of limit lines, auto acquisition areas are provided in the system. There are two setting methods:

**3, 6NM:** Two predefined auto acquisition areas; one between 3.0 and 3.5 nm and the other between 5.5 and 6.0 nm.

**SET:** Two sector-shaped or full-circle auto acquisition areas set by using the trackball.

### To set 3 & 6 NM auto acquisition areas

To activate two predefined auto acquisition areas:

1. Press the E, AUTO PLOT MENU key to show the ARPA 1 menu.
2. Press the [2] key to select menu item 2AUTO ACQ AREA.
3. Further press the [2] key to select (or highlight) menu option 3, 6NM.
4. Press the ENTER key to confirm your selection followed by the E, AUTO PLOT MENU key to close the ARPA 1 menu.

The illustration below shows how the auto acquisition areas are displayed on the screen. Up to 20\* targets within the auto acquisition areas are acquired automatically.

\*If 30 targets have already been acquired manually in the MAN ACQ mode (AUTO OFF on ARPA 1 menu), only 10 more targets can be acquired automatically.

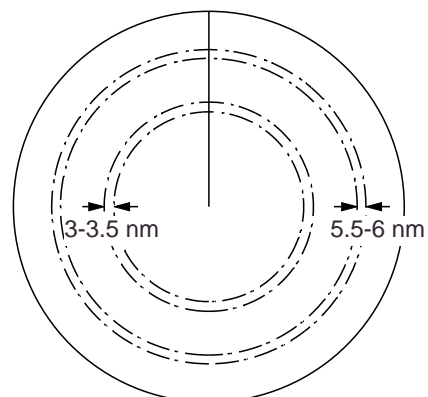

*Predefined auto acquisition areas*

## To set auto acquisition areas with trackball

To set auto acquisition areas with trackball:

1. Press the E, AUTO PLOT MENU key to show the ARPA 1 menu.
2. Press the [2] key to select menu item 2AUT O ACQ AREA.
3. Further press the [2] key to select (or highlight) SET option.
4. Press the ENTER key to conclude your selection. At this point the AUTO ACQ SETTING menu is displayed at the screen bottom.

```
[AUTO ACQ SETTING]
1 [AUTO PLOT 1]
2 1/2
```

5. Press the [2] key to select menu item 21/2 and press the ENTER key . Then, you will see the message as shown below:

```
[AUTO ACQ SETTING]
1 [AUTO PLOT 1]
2 1/2

SET LEFT/RIGHT BOUNDARY
CANCEL PREVIOUS AREA: CANCEL KEY
```

6. Place the cursor at the outer counter-clockwise corner of the area (point A) and press the ENTER key.
7. Place the cursor at the clockwise edge of the area (point B) and press the ENTER key.

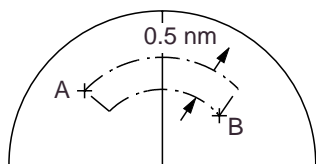

*Automatic acquisition area set by trackball*

**Note:** If you wish to create an auto acquisition area having a 360-degree coverage around own ship, set point B in almost the same direction (approx.  $\pm 3^\circ$ ) as point A and press the ENTER key.

8. Repeat steps 5 to 7 above if you want to set another auto acquisition area with the trackball.
9. Press the [1] key followed by the E, AUTO PLOT MENU key to close the ARPA 1 menu.

An auto acquisition area like the example shown above appears on the display. Note that each auto acquisition area has a fixed radial extension (width) of 0.5 nm.

Note that the auto acquisition areas are preserved in an internal memory of the ARPA even when auto acquisition is disabled or the ARPA is turned off.

## Terminating tracking of targets

When the ARPA has acquired 20 targets automatically, the message AUTO TARGET FULL is displayed in the box at right-hand side of the screen and no more auto acquisition occurs unless targets are lost. You may find this message before you set an auto acquisition area. Should this happen, cancel tracking of less important targets or perform manual acquisition.

## Individual targets

Place the cursor (+) on a target to cancel tracking by operating the trackball. Press the CANCEL key.

## All targets

Press and hold the CANCEL key down more than 3 seconds. In the automatic acquisition mode, acquisition begins again.

## Discrimination between landmass and true targets

A target is recognized as a landmass and thus not acquired if it is 800 m or more in range or bearing direction.



## 2.6 Manual Acquisition

In auto acquisition mode (AUTO ACQ ON), up to 20 targets can be manually acquired in addition to 20 auto acquired targets. When auto acquisition is disabled (AUTO ACQ OFF), up to 40 targets can be manually acquired and automatically tracked.

To manually acquire a target:

1. Place the cursor (+) on a target of interest by operating the trackball.
2. Press the ACQ key on the control panel. The selected plot symbol is marked at the cursor position.

Note that the plot symbol is drawn by broken lines during the initial tracking stage. A vector appears in about one minute after acquisition indicating the target's motion trend. If the target is consistently detected for three minutes, the plot symbol changes to a solid mark. If acquisition fails, the target plot symbol blinks and disappears shortly.

-  (a) Immediately after acquisition—  
Plot symbol shown in broken lines.
-  (b) 20 scans after acquisition—  
Vector appears to show a trend of movement.
-  (c) 60 scans after acquisition—  
Plot symbol shown in solid lines indicating stable tracking.

### Notes:

- 1) For successful acquisition, the target to be acquired should be within 0.1 to 32 nm from own ship and not obscured by sea or rain clutter.
- 2) When you have acquired 40 targets manually, the message MAN TARGET FULL is displayed at the screen bottom. Cancel tracking of non-threatening targets if you wish to acquire additional targets manually. (See "Terminating tracking of acquired targets" on page 2-6.)

## CAUTION

### Target Swap

When a tracked target nears another tracked target, the targets may be "swapped." When two targets acquired either automatically or manually come close to each other, one of the two may become a "lost target." Should this happen manual re-acquisition of the "lost target" may be required after the two targets have separated.

## 2.7 Changing Plot Symbol Size







Press a desired plot symbol key, and the symbol is enlarged for about 7 seconds.

You may also choose plot symbol size. To choose a large or standard size for all plot symbols:

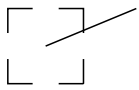
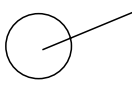
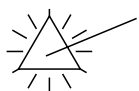
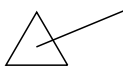

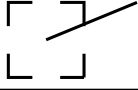
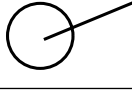

1. Press the E, AUTO PLOT MENU key on the plotting keypad followed by the keys [0] to show the ARPA 2 menu.
2. Press the [3] key to select 3MARK SIZE.
3. Further press the [3] key to select (or highlight) STANDARD or LARGE as appropriate.
4. Press the ENTER key to conclude your selection followed by the E, AUTO PLOT MENU key to close the ARPA 2 menu.

## ARPA symbols

The symbols used in this equipment are designed to comply with Annex E (ARPA Video Symbols) to IEC 872, Operational Requirements for ARPA.

Item	Symbol	Status	Remarks
Automatically acquired targets		Initial stage EPVS symbol NO. 3	Broken square around an echo to indicate the target under acquisition and initial stage of tracking, before steady-state tracking.
		EPVS symbol NO. 3	Between 20 and 60 scans of antenna after acquisition (vector still unreliable)
		Steady tracking EPVS symbol NO. 4a	Solid circle with vector indicating steady state tracking (60 scans after acquisition)
	 (flashing)	CPA alarm EPVS symbol NO. 8	Plot symbol changes to an equilateral triangle flashing to indicate the target is predicted to come into CPA or TCPA.
		CPA alarm acknowledge EPVS symbol NO. 8	Flashing stops after CPA/TCPA alarm is acknowledged.
	 (flashing)	Lost target EPVS symbol NO. 9	Lost target is indicated by flashing diamond symbol. The diamond is formed from two equal triangles.
Manually acquired targets		Initial stage EPVS symbol NO. 3	Plot symbol selected for a target acquired manually is shown in bold broken lines.
		EPVS symbol NO. 3	Bold broken square for 20 - 60 scans of antenna after acquisition.
		Steady tracking EPVS symbol NO. 4a	Manual plot symbol in a bold solid circle (60 scans after acquisition)
	 (flashing)	CPA alarm (collision course) EPVS symbol NO. 8	Plot symbol changes to an equilateral triangle flashing if a target is predicted to come into the preset CPA or TCPA.
		EPVS symbol NO. 8	Flashing stops after CPA/TCPA alarm is acknowledged.
	 (flashing)	Lost target EPVS symbol NO. 9	Lost target is indicated by flashing diamond symbol. The diamond is formed from two equal triangles (one apex up and the other apex down).

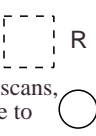
## ARPA symbols (continued)

Item	Symbol	Status	Remarks
Guard zone	 (flashing)	On target passing through operator-set guard zone EPVS symbol NO. 7	Plot symbol changes to an equilateral triangle apex down, flashing together with vector if target entering guard zone (guard ring).
Automatic acquisition area		5.5-6.0 nm, 3-3.5 nm or anywhere EPVS symbol NO. 2	Sector or full circle as selected by the operator.
Target selected for data readout	 1	On selected target EPVS symbol NO. 12	Target data (range, bearing, course, speed, CPA and TCPA).
Reference target	 (In 60 scans, change to  R)	On reference target	Used to calculate own ship's over-the-ground speed (target-based speed) for ground stabilization.
Trial maneuver	<b>T</b> (flashing)	Bottom center EPVS symbol NO. 10	Appears during execution of a trial maneuver.
Auto Plotter performance test	<b>XX</b> (flashing)	Bottom center EPVS symbol NO. 11A	Appears during execution of a performance test (Track Test).

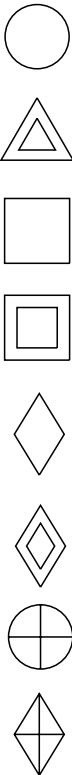
Item	Symbol	Status	Remarks
Non-ARPA symbols			These are non-ARPA symbols but only for E-prot. Not available in the ARPA mode.

## 2.8 Adjusting Brilliance of Plot Marks

1. Press the RADAR MENU key on the plotting keypad to show the FUNCTIONS menu.
2. Press the [9] key to show the BRILLIANCE menu.
3. Press the [7] key to select 7 PLOT BRILL.
4. Further press the [7] key to select (or highlight) a desired brilliance level.
5. Press the ENTER key to confirm your selection followed by the RADAR MENU key to close the FUNCTION menu.

**Note:** Refer to paragraph 1.37 for the BRILLIANCE menu screen.

## 2.9 Displaying Target Data

The Auto Plotter calculates motion trends (range, bearing, course, speed, CPA and TCPA) of all plotted targets.

In head-up and head-up true bearing modes, target bearing, course and speed shown in the upper-right target data field become true (suffix "T") or relative (suffix

"R") to own ship in accordance with the true/relative vector setting. In north-up, course-up and true motion modes, the target data field always displays true bearing, true course and speed over the ground.

Place the cursor on a desired target and press the TARGET DATA key on the plotting keypad. Data on the selected target is displayed at the upper-right corner of the screen. A typical target data display is shown in the illustration below.

**RNG/BRG** (Range/Bearing): Range and bearing from own ship to the selected target with suffix "T" (True) or "R" (Relative).

**CSE/SPD** (Course/Speed): Course and speed are displayed for the selected target with suffix "T" (True) or "R" (relative).

**CPA/TCPA:** CPA(Closest Point of Approach) is the closest range a target will approach to own ship. TCPA is the time to CPA. Both CPA and TCPA are automatically calculated. When a target ship has passed clear of own ship, CPA is prefixed with an asterisk such as, CPA\*1.5NM. TCPA is counted to 99.9 min and beyond this, it is indicate as TCPA>\*99.9MIN.

**BCR/BCT:** Bow crossing range is a range of a target which will pass dead ahead of own ship at a calculated distance. BCT is the time when BCR occurs.

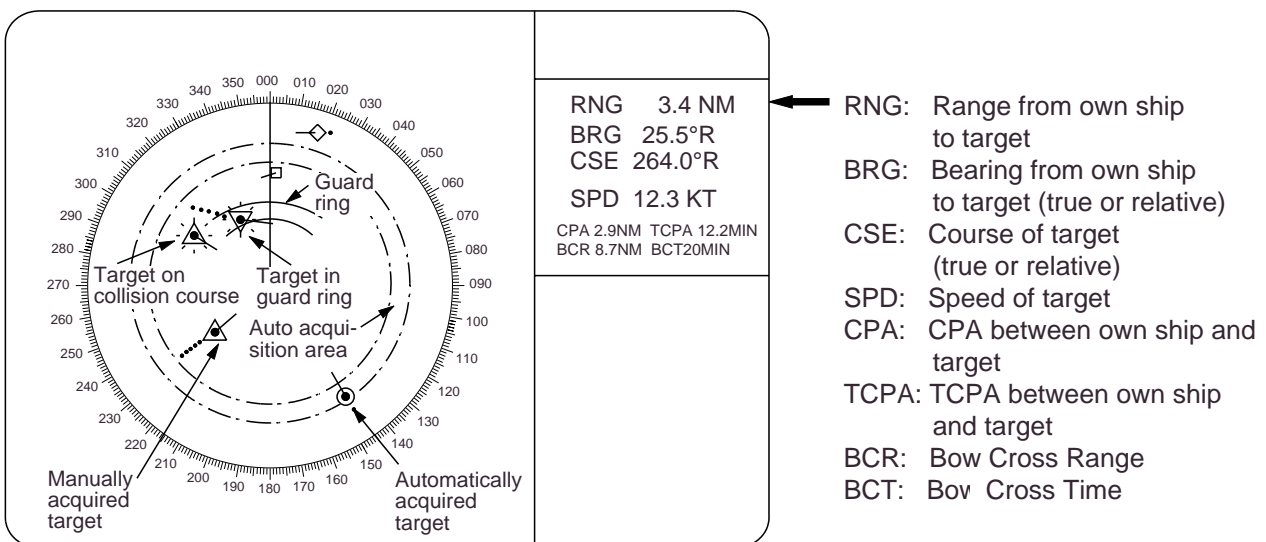



## 2.10 Mode and Length of Vectors

### True or relative vector

Target vectors can be displayed relative to own ship's heading (relative) or with reference to the north (true).

Press the VECTOR TRUE/REL key to select true or relative vectors. This feature is available in all presentation modes (gyrocompass must be working correctly). The current vector mode is indicated at the upper-right corner of the screen.

### True vector

With true vectors the radar display will look like the one shown below in head-up mode.

In the true motion mode, all fixed targets such as land, navigational marks and ships at anchor remain stationary on the radar screen with vector length zero. But in the presence of wind and/or current, true vectors appear on fixed targets representing the reciprocal of set and drift affecting own ship unless set and drift values are properly entered (see paragraph 2.12).

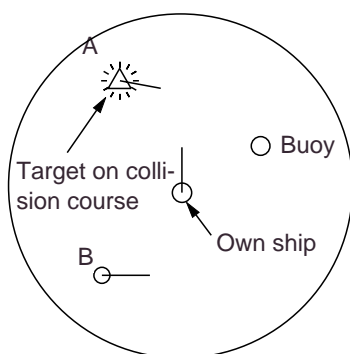

(a) True vectors in head-up mode

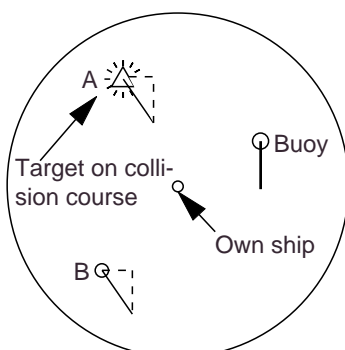

(b) Relative vectors in head-up mode

### Relative vector

With relative vectors the radar display will look like (b).

Relative vectors on targets which are not moving over the ground such as land, navigational marks and ships at anchor will represent the reciprocal of own ship's ground track. A target of which vector extension passes through own ship is on the collision course. (Dotted lines in the figure are for explanation only.)

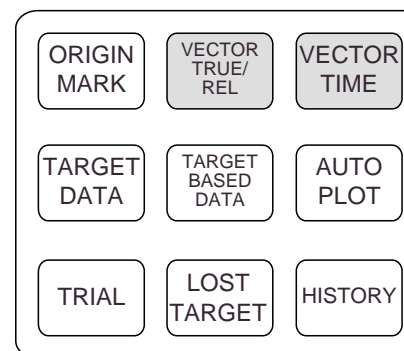

### Vector time

Vector time (or the length of vectors) can be set to 30 seconds, 1, 2, 3, 6, 12, 15 or 30 minutes and the selected vector time is indicated at the upper-right corner of the screen.

Press the VECTOR TIME key to select desired vector time. The vector tip shows an estimated position of the target after the selected vector time elapses. It can be valuable to extend the vector length to evaluate the risk of collision with any target.

## 2.11 Past Position Display

The ARPA displays equally time-spaced dots marking the past positions of any targets being tracked.

A new dot is added every minute (or at preset time intervals) until the preset number is reached. If a target changes its speed, the spacing will be uneven. If it changes the course, its plotted course will not be a straight line.



## Displaying and erasing past positions

To display past positions, press the HISTORY key to display past positions of targets being tracked. The label HISTORY appears at the upper-right corner of the screen.

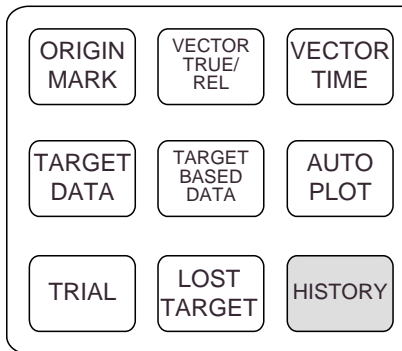

To erase past positions, press the HISTORY key again.

## Selecting the number of dots and past position plot intervals

1. Press the E, AUTO PLOT MENU key on the plotting keyboard to show the ARPA 1 menu.

Hit [E, AUTO PLOT MENU].

[ARPA1]	
1	AUTO ACQ OFF/ON
2	AUTO ACQ AREA 6 NM/SET
3	GUARD RING OFF/ON
4	GUARD RING SET
5	
6	CPA, TCPA SET CPA 00.0NM TCPA 00.0MIN
7	HISTORY POINTS 5/10/20*
8	HISTORY INTERVAL 30S/1/3/3/6MIN
0	[ARPA 2]

\*5/10 only on IMO-type

2. Press the [7] key to select menu item 7HISTORY POINTS.
3. Further press the [7] key to select a desired number of past positions (5, 10, 20, 30, 100, 150 or 200). The IMO-type has the selection of only 5 or 10.
4. Press the ENTER key to confirm your selection.
5. Press the [8] key to select menu item 8HISTORY INTERVAL.

6. Further press the [8] key to select a desired past position plot interval (30 seconds, 1, 2, 3 or 6 minutes).
7. Press the ENTER key to conclude your selection.
8. Press the E, AUTO PLOT MENU key to close the menu.

## 2.12 Setting CPA/TCPA Alarm Ranges

The ARPA continuously monitors the predicted range at the Closest Point of Approach (CPA) and predicted time to CPA (TCPA) of each tracked target to own ship.

When the predicted CPA of any target becomes smaller than a preset CPA alarm range and its predicted TCPA less than a preset TCPA alarm limit, the ARPA releases an aural alarm and displays the warning label COLLISION on the screen. In addition, the ARPA symbol changes to a triangle and flashes together with its vector.

Provided that this feature is used correctly, it will help prevent the risk of collision by alerting you to threatening targets. It is important that GAIN, A/C SEA, A/C RAIN and other radar controls are properly adjusted.

CPA/TCPA alarm ranges must be set up properly taking into consideration the size, tonnage, speed, turning performance and other characteristics of own ship.

### CAUTION

#### CPA/TCPA Alarm

The CPA/TCPA alarm feature should never be relied upon as the sole means for detecting the risk of collision.

The navigator is not relieved of the responsibility to keep visual lookout for avoiding collisions, whether or not the radar or other plotting aid is in use.

To set the CPA/TCPA alarm ranges:

1. Press the E, AUTO PLOT MENU key on the plotting keypad to show the ARPA 1 menu.
2. Press the [6] key to select menu item 6CP A, TCPA SET. At this point, a highlight cursor appears at the "CPA x.xNM" field.
3. Enter the CPA alarm range in nautical miles (max 9.9 min) without omitting leading zeroes, if any, and press the ENTER key. The highlight cursor now moves to the "TCPA xx.xMIN" field.
4. Enter the TCPA alarm limit in minutes (max. 99.0 min) without omitting leading zeroes, if any, and press the ENTER key.
5. Press the E, AUTO PLOT MENU key to close the menu.

### Silencing CPA/TCPA aural alarm

Press the AUDIO OFF key to acknowledge and silence the CPA/TCPA aural alarm.

The warning label COLLISION and the flashing of the triangle plot symbol and vector remain on the screen until the dangerous situation is gone or you intentionally terminate tracking of the target by using the CANCEL key.

## 2.13 Setting a Guard Zone

When a target transits the operator-set guard zone, the buzzer sounds and the indication GUARD RING appears at the screen bottom. The target causing the warning is clearly indicated with an inverted flashing triangle.

 <b>CAUTION</b>
<b>Guard Zone</b>
The Guard Zone (Guard Ring) should never be relied upon as a sole means for detecting the risk of collision. The navigator is not relieved of the responsibility to keep a visual lookout for avoiding collisions, whether or not the radar or other plotting aid is in use.

### Activating the guard zone

No.1 Guard Zone is available between 3 and 6 nm with a fixed range depth of 0.5 nm. No.2 GZ may be set anywhere when No.1 GZ is valid.

To set and activate the guard zone:

1. Press the E, AUTO PLOT MENU key on the plotting keyboard to show the ARPA 1 menu.
2. Press the [3] key to select menu item 3GUARD RING.
3. Further press the [3] key to select (or highlight) ON to activate the guard zone.
4. Press the ENTER key to conclude your selection.
5. Press the [4] key to select menu item 4GUARD RING SET. At this point the GUARD SETTING menu is displayed at the screen bottom.

<b>[GUARD SETTING]</b>
1 [AUTO PLOT 1] 2 1/2
SET LEFT/RIGHT BOUNDARY CANCEL PREVIOUS AREA: CANCEL KEY

6. Press the [2] key and ENTER key. ([2] [2] [ENTER] when setting the no.2 ring.)

7. Referring to figure below, place the cursor at the outer left corner of the area (point A) and press the ENTER key.
8. Place the cursor at the right edge of the area (point B) and press the ENTER key.

**Note:** If you wish to create a guard zone having a 360-degree coverage around own ship, set point B in almost the same direction (approx.  $\pm 3^\circ$ ) as point A and press the ENTER key.

9. Press the [1] key followed by the E, AUTO PLOT MENU key to close the ARPA 1 menu.

The guard zone as an example shown below appears on the display. Note that the guard zone has a fixed radial extension (width) of 0.5 nm. The label GZ is displayed in the box at the upper-right on the screen when guard zone is enabled.

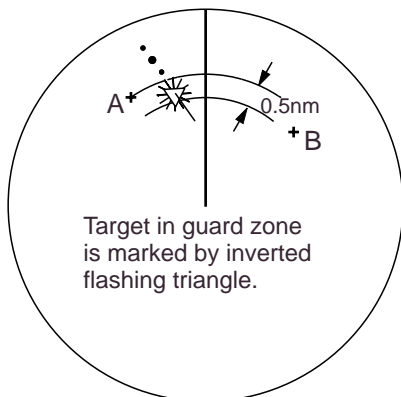

### Deactivating the guard zone (guard ring)

1. Press the E, AUTO PLOT MENU key on the plotting keyboard to show the ARPA 1 menu.
2. Press the [3] key to select menu item 3GUARD RING.
3. Further press the [3] key to select (or highlight) OFF to deactivate the guard zone.
4. Press the ENTER key to conclude your selection followed by the E, AUTO PLOT MENU key to close the ARPA 1 menu.

### Silencing the guard zone (guard ring) audible alarm

Press the AUDIO OFF key to acknowledge and silence the guard zone audible alarm.

## 2.14 Operational Warnings

There are six main situations which cause the Auto Plotter to trigger visual and aural alarms:

- CPA/TCPA alarm
- Guard zone alarm
- Lost target alarm
- Target full alarm for manual acquisition
- Target full alarm for automatic acquisition
- System failures

The audible alarm can be set to OFF through the AUTO PLOT 2 menu.

### CPA/TCPA alarm

Visual and aural alarms are generated when the predicted CPA and TCPA of any target become less than their preset limits. Press the AUDIO OFF key to acknowledge and silence the CPA/TCPA aural alarm.

### Guard zone (guard ring) alarm

Visual and audible alarms are generated when a target transits the operator-set guard zone. Press the AUDIO OFF key to acknowledge and silence the guard zone audible alarm. (Refer to paragraph 2.14 Setting a Guard Zone for further information.)

### Lost target alarm

When the system detects a loss of a tracked target, the target symbol becomes a flashing diamond ( $\diamond$ ) and the label "LOST" appears at the screen bottom. At the same time, an aural alarm is produced for one second.

Press the LOST TARGET key to acknowledge the lost target alarm. Then, the lost target mark disappears.

## Target full alarm

When the memory becomes full, the memory full status is indicated and the relevant indication appears on the screen and a short beep sounds.

## Manually acquired targets

The indication "MAN TARGET FULL" appears at the screen bottom and a short beep tone sounds when the number of manually acquired targets reaches 20 or 40 depending on whether auto acquisition is activated or not.

## Automatically acquired targets

The indication "AUTO TARGET FULL" appears at the screen bottom and a short beep tone sounds when the number of automatically acquired targets reaches 20.

## System failure alarm

When the ARP board receives no signal input from the radar or external equipment, the screen shows both "SYSTEM FAIL" associated with an indication denoting offending equipment, also releasing an aural alarm. The missing signals are denoted as shown below:

Missing Signal	Indication
*Speed log signal	LOG
*Gyrocompass	GYRO
Trigger signal from radar	T
Video from radar	V
*Bearing signal from radar antenna	B
*Heading pulses from radar antenna	H

\*The alarm is available with or without ARPA.

## 2.15 Trial Maneuver

Trial simulates the effect on all tracked targets against own ship's maneuver without interrupting the updating of target information.

There are two types of trial maneuvers: static and dynamic.

### Dynamic trial maneuver

A dynamic trial maneuver displays predicted positions of the tracked targets and own ship. You enter own ship's intended speed and course with a certain "delay time." Assuming that all tracked targets maintain their present speeds and courses, the targets' and own ship's future movements are simulated in one-second increments indicating their predicted positions in one-minute intervals as illustrated below.

The delay time represents the time lag from the present time to the time when own ship will actually start to change her speed and/or course. You should therefore take into consideration own ship's maneuvering characteristics such as rudder delay, turning delay and acceleration delay. This is particularly important on large vessels. How much the delay is set the situation starts immediately and ends in a minute.

In the example shown below, own ship will advance straight ahead (even after a maneuver) for a delay time of 5 minutes and then alters speed and course until operator-specified intended speed and course are achieved (position OS7 in this example).

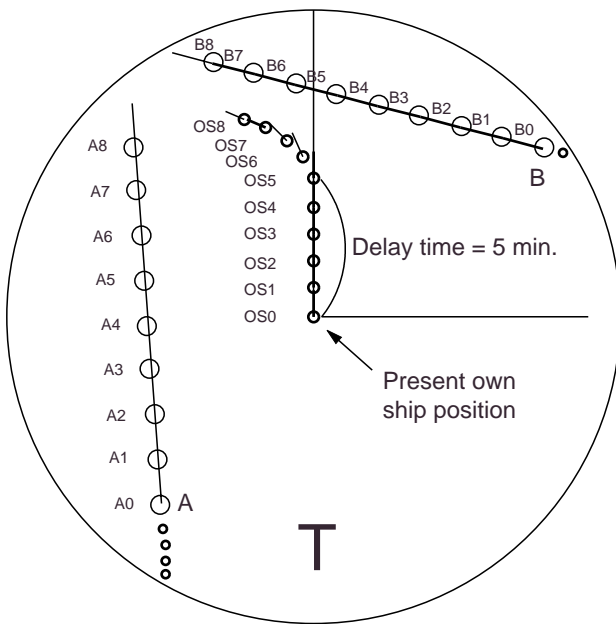

*Dynamic trial maneuver*

Note that once a dynamic trial maneuver is initiated, you cannot alter own ship's trial speed, course or delay time until the trial maneuver is terminated.

### Static trial maneuver

A static trial maneuver displays only the final situation of the simulation. If you enter the same trial speed, course and delay time under the same situation as in the aforementioned example of dynamic trial maneuver, the screen will instantly show position OS7 for own ship, position A7 for target A and position B7 for target B, omitting the intermediate positions. Thus, the static trial maneuver will be convenient when you wish to know the maneuver result immediately.

**Note:** For accurate simulation of ship movements in a trial maneuver, own ship's characteristics such as acceleration and turning performance should be properly set in initial settings at the time of installation.

To perform a trial maneuver:

1. Press the E, AUTO PLOT MENU key on the plotting keypad followed by the [0] key to show the ARPA 2 menu.

[ARPA 2]	
1	[ARPA 1]
2	TRIAL MANEUVER      STATIC/DYNAMIC
3	MARK SIZE            STANDARD/LARGE
4	CPA, TCPA DISPLAY   OFF/ON
5	SET DRIFT            OFF/MAN
	SET    xxx.x°
	DRIFT xx.xKT
6	GUARD RING, ACQ    NORTH/CRT
	LINE STABILIZE
7	SPEED REF            WT/BT
8	INPUT SIG CHECK
9	ARP TRACK TEST
0	INITIAL SETTING

2. Press the [2] key to select 2TRIAL MODE.
3. Further press the [2] key to select (or highlight) STATIC or DYNAMIC trial maneuver option as appropriate.
4. Press the ENTER key to conclude your selection followed by the E, AUTO PLOT MENU key to close the ARPA 2 menu.
5. Press the VECTOR TRUE/REL key to select true or relative vector.

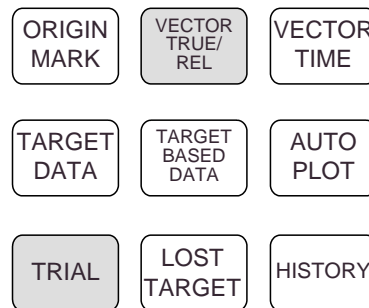

6. Press the TRIAL key. The TRIAL DATA SETTING menu appears at the screen bottom associated with the current own ship's speed and course readouts.

TRIAL DATA SETTING [DYNAMIC MODE]:	
SPEED (VRM)	15.0KT
COURSE (EBL)	53.6°
DELAY TIME	xx.x MIN

**Note:** The second line reads [STATIC MODE] in the event of a static trial maneuver.

7. Enter own ship's intended speed, course and delay time in the following manner:

Speed:      Set with the VRM control.  
Course:     Set with the EBL control.

Delay time: Enter in minutes by hitting numeral keys. This is the time after which own ship takes a new situation, not the time the simulation begins. Change the delay time according to own ship loading condition, etc.

8. Press the TRIAL key again to start a trial maneuver.

Trial maneuver takes place in three minutes with the letter "T" displayed at the bottom of the screen. If any tracked target is predicted to be on a collision course with own ship (that is, the target ship comes within preset CPA/TCPA limits), the target plot symbol changes to a triangle ( $\Delta$ ) and flashes. If this happens, change own ship's trial speed, course or delay time to obtain a safe maneuver. The trial maneuver is automatically terminated and the normal radar picture is restored three minutes later.

### Terminating trial maneuver

Press the TRIAL key again at any time.

## 2.16 ARPA Track Test

Test program is provided for assessing ARPA overall performance. Note that normal operation is interrupted and the label "XX" is displayed at the bottom of the screen during this test. The Test may be terminated at any moment.

To execute the ARPA track test:

1. Select north-up mode presentation on the 12 nm range.
2. Enter manual speed of 0 knots.
3. Press the E, AUTO PLOT MENU key on the plotting keypad followed by the [0] key to show the ARPA 2 menu.
4. Press the [9] key to select 9 ARP TRACK TEST. A track test picture appears on the screen.
5. Press the ENTER key.

6. It takes approximately three minutes for all vectors to be displayed. The track test display does not need echo signal, gyro nor speed log input. Seven targets having various speeds and courses, as shown in the table on the next page, are simulated automatically.

7. The track test continues for 5 minutes and then repeats.

To terminate the track test, press the ST-BY/TX key twice and the ST-BY display will appear.

CPA and TCPA shown below are initial values.

Target	Course	Speed (kt)	CPA (nm)	TCPA (min)
Target A	90.0° T	10.0	1.0	10.4
Target B	0.0° T	0.0	4.0	*
Target C	180.0° T	10.0	1.7	28.2
Target D	216.5° T	23.8	0.9	15.0
Target E	273.5° T	14.2	6.0	22.5
Target F	180.0° T	20.0	0.0	30.0
Target G	24.6° T	15.6	4.0	43.6

\* Invalid value

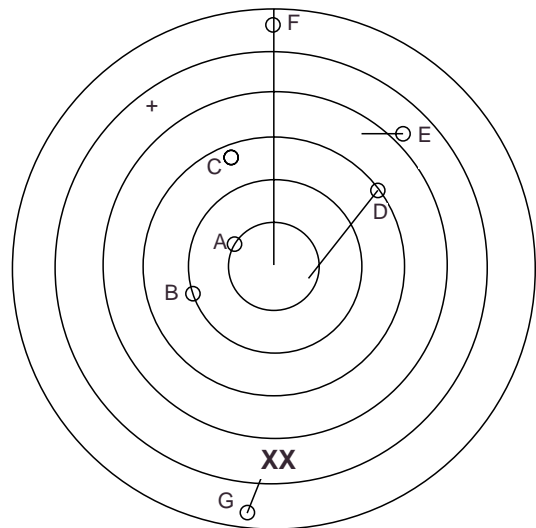

**Note:** Alphabets mark targets in the above table and figure; on the actual display figures mark targets. Note that target numbering varies.

## 2.17 Criteria for Selecting Targets for Tracking

The FURUNO ARPA video processor detects targets in midst of noise and discriminates radar echoes on the basis of their size. Target whose echo measurements are greater than those of the largest ship in range or tangential extent are usually land and are displayed only as normal radar video. All smaller ship-sized echoes which are less than this dimension are further analyzed and regarded as ships and displayed as small circles superimposed over the video echo.

When a target is first displayed, it is shown as having zero true speed but develops a course vector as more information is collected. In accordance with the International Marine Organization Automatic Radar Plotting Aid (IMO ARPA) requirements, an indication of the motion trend should be available in 1 minute and full vector accuracy in 3 minutes of plotting. The FURUNO ARPAs comply with these requirements.

### Acquisition and tracking

A target which is hit by 5 consecutive radar pulses is detected as a radar echo. Manual acquisition is done by designating a detected echo with the trackball. Automatic acquisition is done in the acquisition areas when a target is detected 5-7 times continuously depending upon the congestion. Tracking is achieved when the target is clearly distinguishable on the display for 5 out of 10 consecutive scans whether acquired automatically or manually.

Targets not detected in 5 consecutive scans become "lost targets."

### Quantization

The entire picture is converted to a digital form called "Quantized Video." A sweep range is divided into small segments and each range element is "1" if there is radar echo return above a threshold level, or "0" if there is no return.

The digital radar signal is then analyzed by a ship-sized echo discriminator. As the antenna scans, if there are 5 consecutive radar pulses with I's indicating an echo presence at the exact same range, a target "start" is initiated. Since receiver noise is random, it is not three bang correlated, and it is filtered out and not classified as an echo.

The same is true of radar interference. Electronic circuits track both the closest and most distant edges of the echo. At the end of the scanning of the echo, the discriminator indicates the measured maximum range extent and total angular extent subtended by the echo. If the echo is larger than a ship-sized echo in range extent and/or angular width, adjusted as a function of range, it is declared to be a coastline and the closest edge is put into memory as a map of the area. This land outline is used to inhibit further acquisition and tracking of ship sized echoes beyond the closest coast outline. 5 consecutive scans of coastal outline are retained in memory to allow for signal variation. All smaller echoes are declared to be ship sized and the middle of the leading edge is used to provide precise range and bearing coordinates of each echo on every scan. This range/bearing data is matched to previous data and analyzed from scan-to-scan for consistency. When it is determined to be as consistent as a real target, automatic acquisition occurs and tracking is initiated. Continued tracking and subsequent calculation develop the relative course and speed of the target just as a man would do when plotting the relative course and speed of the target on the scope with a grease pencil.

The true course and speed of own ship are computed from own ship's gyro and speed inputs, and the resulting course and speed of each tracked target is easily computed by vector summing of the relative motion with own ship's course and speed. The resulting true or relative vector is displayed for each of the tracked targets. This process is updated continually for each target on every scan of the radar.



## **Automatic acquisition areas and suppression lines**

Performance of auto-acquisition is enhanced by controlling the limit lines (suppression line) in the former series of FURUNO ARPAs. In this new series of ARPAs, the automatic acquisition rings are used instead of the limit lines.

Auto acquisition rings work as suppression lines when viewed from the opposite direction. They should be placed clear of a landmass or shoreline. The acquisition areas may be a full 360 degree circle or sector of any angles are gyro stabilize.

## **Qualitative description of tracking error**

The FURUNO ARPA accuracies comply with or exceed IMO standards.

## **Own ship maneuvers**

For slow turns there is no effect. For very high turning rates (greater than 150°/minute, depending on gyro), there is some influence on all tracked targets which last for a minute or two and then all tracked targets revert to full accuracy.

## **Other ship maneuvers**

Target ship courses, lag 15 to 30 seconds at high relative speed, or 3 to 6 seconds at low (near 0) relative speed. It is less accurate during a turn due to lag, but accuracy recovers quickly.

## **2.18 Factors Affecting ARPA Functions**

### **Sea returns**

If the radar anti-clutter control is adjusted properly, there is no serious effect because distant wave clutter, not eliminated by this control, is filtered out by more than one bang correlation and scan-to-scan matching of data.

## **Rain and snow**

Clutter can be acquired and tracked as targets. Adjust the A/C RAIN control. If it is heavy rain, switch to S-band if provided, or switch on the interference rejector on the radar. If heavy clutter still exists, switch to manual acquisition. Accuracy can be affected.

## **Low clouds**

Usually no effect. If necessary, adjust the A/C RAIN control.

## **Non-synchronous emissions**

No effect.

## **Low gain**

Insufficient or low radar receiver gain will result in some targets not being acquired at long distance. ARPA display will be missing on one or more targets that could only be visible if the radar sensitivity control (GAIN control) were increased.

The setting of the correct radar receiver gain is not critical but the target should be on the radar PPI and be clearly visible and well defined.

Manual acquisition is done if a target is positively displayed more than once. Automatic acquisition is done when the target is detected 5-7 times continuously. Tracking is achieved when the target is detected 5 times (not necessarily continuously) out of 10 scans. If not detected 6 times out of 10 scans, the target will become a "lost target." The ARPA will acquire a radar echo that is present once in every six antenna scans and continue tracking if 1 in 10.

## **Second trace echoes**

When the radar beam is super refracted, strong echoes may be received at such long ranges that they appear on a different timebase sweep than the transmitted



pulse. This gives an incorrect range indication. Second and third trace echoes can be tracked if they are consistent enough to meet acquisition and tracking criteria but target course and speed data will be in error.

To receive radar beacon or SART signals, turn off the radar interference rejection and echo average which operate on the correlation technique.

## **Blind and shadow sectors**

Radar shadow or blind areas caused by obstructions aboard ship, for example, funnels and masts, in the path of the radar beam can result in reduction of radar beam intensity in that particular direction. This may eliminate the detection of some targets. The ARPA system will lose track of targets shortly after they are lost on the radar picture and if they remain in a blind zone. These targets will however be acquired and tracked when they pass out of the blind zone and again present normal radar echo. The angular width and bearing of any shadow sector should be determined for their influence on the radar. In certain cases false echoes in the shadow sector cause the ARPA system to acquire, track, and vector them. Shadow sectors should be avoided.

## **Indirect echoes**

A target at close range is usually picked up directly, but it can also be received as reflection from a large, flat surface. This will result in the radar presenting two or more echoes on the display, each at a different range. The ARPA can acquire and track the false echo if it is detected by five consecutive scans. Reduction in radar GAIN can eliminate the multiple echoing but care should be taken as range detection also will be reduced.

## **Radar interference**

If interference is extreme due to another radar operating at close range, spiral "dotting" and/or false targets may appear momentarily. The interference rejector can clear the display.

# 3. RADAR OBSERVATION

## 3.1 General

### Minimum and maximum ranges

#### Minimum range

The minimum range is defined by the shortest distance at which, using a scale of 1.5 or 0.75 nm, a target having an echoing area of 10 m<sup>2</sup> is still shown separate from the point representing the antenna position.

It is mainly dependent on the pulselength, antenna height, and signal processing such as main bang suppression and digital quantization. It is a good practice to use a shorter range scale as far as it gives favorable definition or clarity of picture. The IMO Resolution A. 477 (XII) and IEC 936 require the minimum range to be less than 50 m. All FURUNO radars satisfy this requirement.

#### Maximum range

The maximum detecting range of the radar, R<sub>max</sub>, varies considerably depending on several factors such as the height of the antenna above the waterline, the height of the target above the sea, the size, shape and material of the target, and the atmospheric conditions.

Under normal atmospheric conditions, the maximum range is equal to the radar horizon or a little shorter. The radar horizon is longer than the optical one by about 6% because of the diffraction property of the radar signal. The R<sub>max</sub> is given in the following equation.

$$R_{\max} = 2.2 \times (\sqrt{h_1} + \sqrt{h_2})$$

where R<sub>max</sub>: radar horizon (nautical miles)  
h<sub>1</sub>: antenna height (m)  
h<sub>2</sub>: target height (m)

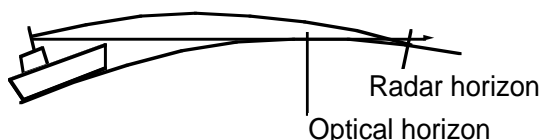

For example, if the height of the antenna above the waterline is 9 meters and the height of the target is 16 meters, the maximum radar range is;

$$R_{\max} = 2.2 \times (\sqrt{9} + \sqrt{16}) = 2.2 \times (3 + 4) = 15.4 \text{ nm}$$

It should be noted that the detection range is reduced by precipitation (which absorbs the radar signal).

#### X-band and S-band

In fair weather, the above equation does not give a significant difference between X- and S-band radars. However, in heavy precipitation condition, an S-band radar would have better detection than an X-band radar.

#### Radar resolution

There are two important factors in radar resolution (discrimination): bearing resolution and range resolution.

#### Bearing resolution

Bearing resolution is the ability of the radar to display as separate pips the echoes received from two targets which are at the same range and close together. It is proportional to the antenna length and reciprocally proportional to the wavelength. The length of the antenna radiator should be chosen for a bearing resolution better than 2.5° (IMO Resolution). This condition is normally satisfied with a radiator of 1.2 m (4 ft) or longer in the X-band. The S-band radar requires a radiator of about 12 feet (3.6 m) or longer.

#### Range resolution

Range resolution is the ability to display as separate pips the echoes received from two targets which are on the same bearing and close to each other. This is deter-

mined by pulselength only. Practically, a 0.08 microsecond pulse offers the discrimination better than 25 m as do so with all FURUNO radars.

Test targets for determining the range and bearing resolution are radar reflectors having an echoing area of 10 m<sup>2</sup>.

### Bearing accuracy

One of the most important features of the radar is how accurately the bearing of a target can be measured. The accuracy of bearing measurement basically depends on the narrowness of the radar beam. However, the bearing is usually taken relative to the ship's heading, and thus, proper adjustment of the heading marker at installation is an important factor in ensuring bearing accuracy. To minimize error when measuring the bearing of a target, put the target echo at the extreme position on the screen by selecting a suitable range.

### Range measurement

Measurement of the range to a target is also a very important function of the radar. Generally, there are two means of measuring range: the fixed range rings and the variable range marker (VRM). The fixed range rings appear on the screen with a predetermined interval and provide a rough estimate of the range to a target. The variable range marker's diameter is increased or decreased so that the marker touches the inner edge of the target, allowing the operator to obtain more accurate range measurements.

## 3.2 False Echoes

Occasionally echo signals appear on the screen at positions where there is no target or disappear even if there are targets. They are, however, recognized if you understand the reason why they are displayed. Typical false echoes are shown below.

### Multiple echoes

Multiple echoes occur when a transmitted pulse returns from a solid object like a large ship, bridge, or breakwater. A second, a third or more echoes may be observed on the display at double, triple or other multiples of the actual range of the target as shown below. Multiple reflection echoes can be reduced and often removed by decreasing the gain (sensitivity) or properly adjusting the A/C SEA control.

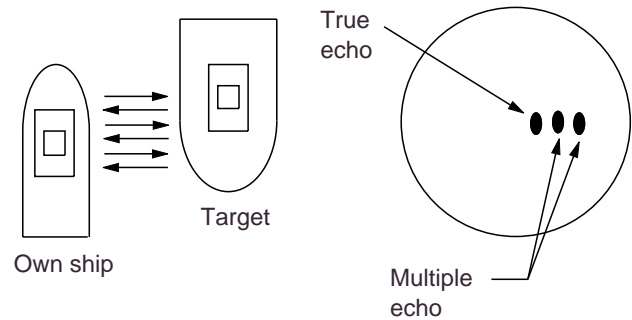

### Sidelobe echoes

Every time the radar pulse is transmitted, some radiation escapes on each side of the beam, called "sidelobes." If a target exists where it can be detected by the side lobes as well as the main lobe, the side echoes may be represented on both sides of the true echo at the same range. Side lobes show usually only on short ranges and from strong targets. They can be reduced through careful reduction of the gain or proper adjustment of the A/C SEA control.

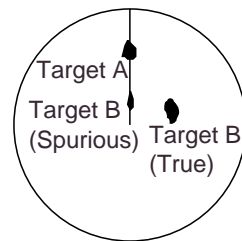

### Virtual image

A relatively large target close to your ship may be represented at two positions on the screen. One of them is the true echo directly reflected by the target and the other

is a false echo which is caused by the mirror effect of a large object on or close to your ship as shown in the figure below. If your ship comes close to a large metal bridge, for example, such a false echo may temporarily be seen on the screen.

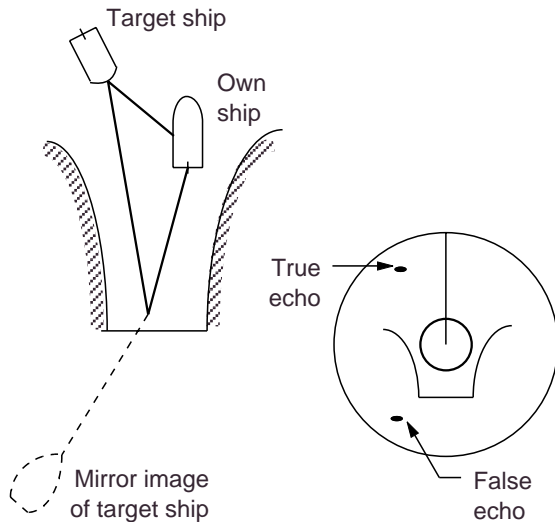

### Shadow sectors

Funnels, stacks, masts, or derricks in the path of the antenna block the radar beam. If the angle subtended at the scanner is more than a few degrees, a non-detecting sector may be produced. Within this sector targets can not be detected.

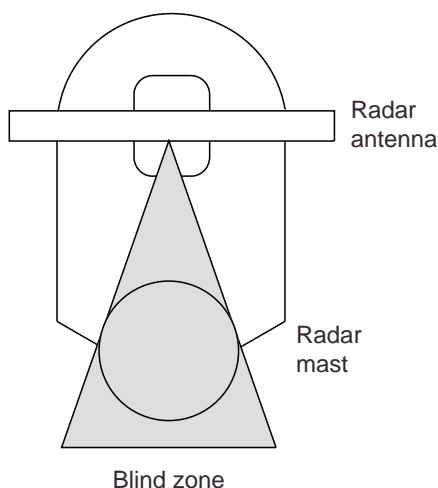

### 3.3 SART (Search and Rescue Transponder)

A Search and Rescue Transponder (SART) may be triggered by any X-Band (3 cm) radar within a range of approximately 8 nm. Each radar pulse received causes it to transmit a response which is swept repetitively across the complete radar frequency band. When interrogated, it first sweeps rapidly ( $0.4 \mu\text{s}$ ) through the band before beginning a relatively slow sweep ( $7.5 \mu\text{s}$ ) through the band back to the starting frequency. This process is repeated for a total of twelve complete cycles. At some point in each sweep, the SART frequency will match that of the interrogating radar and be within the pass band of the radar receiver. If the SART is within range, the frequency match during each of the 12 slow sweeps will produce a response on the radar display, thus a line of 12 dots equally spaced by about 0.64 nautical miles will be shown.

When the range to the SART is reduced to about 1 nm, the radar display may show also the 12 responses generated during the fast sweeps. These additional dot responses, which also are equally spaced by 0.64 nm, will be interspersed with the original line of 12 dots. They will appear slightly weaker and smaller than the original dots.

#### General procedure for detecting SART response

1. Use range scale of 6 or 12 nm as the spacing between the SART responses is about 0.6nm (1125 m) to distinguish the SART.
2. Turn off the automatic clutter suppression.
3. Turn off the Interference Rejector.
4. Turn off the Echo Average.

When the range to the SART is reduced to about 1 nm, the radar display may show also the 12 responses generated during the fast sweeps. These additional dot responses, which also are equally spaced by 0.64 nm, will be interspersed with the original line of 12 dots. They will appear slightly weaker and smaller than the original dots.

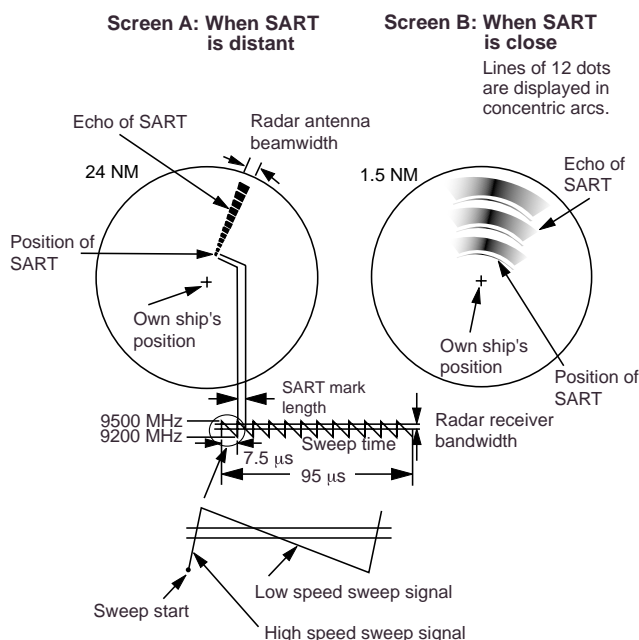

## General procedure for detecting SART response

1. Use range scale of 6 or 12 nm as the spacing between the SART responses is about 0.6nm (1125 m) to distinguish the SART.
2. Turn off the automatic clutter suppression.
3. Turn off the Interference Rejector.
4. Turn off the Echo Average.

## General remarks on receiving SART

### SART range errors

When responses from only the 12 low frequency sweeps are visible (when the SART is at a range greater than about 1 nm), the position at which the first dot is displayed may be as much as 0.64 nm beyond the true position of the SART. When the range closes so that the fast sweep responses are seen also, the first of these will be no more than 150 meters beyond the true position.

### Radar bandwidth

This is normally matched to the radar pulselength and is usually switched with the range scale and the associated pluslength. Narrow bandwidths of 3-5 MHz are used with long pulses on long range and wide bandwidths of 10-25 MHz with short pulses on short ranges.

Any radar bandwidth of less than 5 MHz will attenuate the SART signal slightly, so it is preferable to use a medium bandwidth to ensure optimum detection of the SART.

### Radar side lobes

As the SART is approached, side lobes from the radar antenna may show the SART responses as a series of arcs or concentric rings. These can be removed by the use of the anti-clutter sea control although it may be operationally useful to observe the side lobes as they may be easier to detect in clutter conditions and also they will confirm that the SART is near to the ship.

### Gain

For maximum range SART detection the normal gain setting for long range detection should be used, that is, with background noise speckle visible.

### A/C SEA control

For optimum range SART detection, this control should be set to the minimum. Care should be exercised as wanted target in sea clutter may be obscured. Note also that in clutter conditions the first few dots of the SART response may not be detectable, irrespective of the setting of the anti-clutter sea control. In this case, the position of the SART may be estimated by measuring 9.5 nm miles from the furthest dot back towards own ship.

Some sets have automatic/manual anti-clutter sea control facilities in which case the operator should switch to manual.

### A/C RAIN control

This should be used normally (to break up areas of rain) when trying to detect a SART response which, being a series of dots, is not affected by the action of the anti-clutter rain circuitry. Note that Racon responses, which are often in the form of a long flash, will be affected by the use of this control.

Some sets have automatic/manual anti-clutter rain control facilities in which case the operator should switch to manual.

**Note:** This SART information is excerpted from IMO SN/Circ 197 Operation of Marine Radar for SART Detection.

## 3.4 RACON (Radar Beacon)

A racon is a radar transponder which emits a characteristic signal when triggered by a ship's radar (usually only the 3 centimeter band). The signal may be emitted on the same frequency as that of the triggering radar, in which case it is superimposed on the ship's radar display automatically.

The racon signal appears on the PPI as a radial line originating at a point just beyond the position of the radar beacon or as a Morse code signal (figure below) displayed radially from just beyond the beacon.

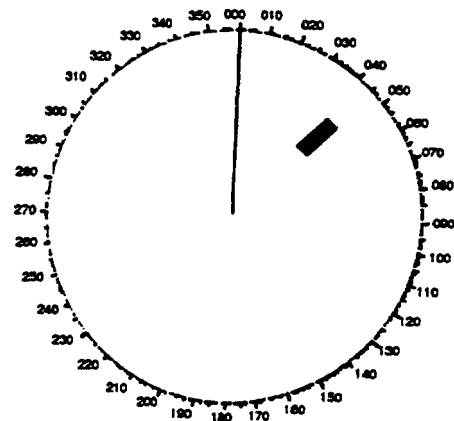

# 4. MAINTENANCE



DANGER



**DANGER: Electrical Shock Hazard**

This equipment contains high voltages which can cause death at several internal circuits including a cathode ray tube (CRT) which uses several thousand volts. Any internal adjustment, servicing and repair shall only be performed by qualified service personnel totally familiar with electrical circuits and servicing of the equipment. A residual charge remains in capacitors and other devices several minutes after turning off the power. It is therefore essential to wait at least 3 minutes to allow residual charge to subside before accessing the inside of the equipment. Special care must be taken when approaching the following parts:

- Power supply circuit (Display unit and separate power supply units)
- CRT circuit (Display unit)
- Modulator circuit and magnetron (Antenna unit or separate transceiver unit)
- Motor drive circuit (Antenna unit)

WARNING



**WARNING: When Working on the Antenna Unit**

Wear a safety belt and a hard hat when working on the antenna unit. Always make sure that the radar is POWERED OFF and the Antenna switch in the display unit is OFF before working on the antenna unit. Also take all steps to ensure that the radar will not be accidentally operated by someone else, to prevent the potential risk of being struck by the rotating antenna and exposure to RF radiation hazards.

Periodic checks and maintenance are important for proper operation of any electronic systems. This chapter contains maintenance instructions to be followed to obtain optimum performance and the longest possible life of the equipment.

## 4.1 Periodic Maintenance Schedule

Interval	Check point	Check and measures	Remarks
Weekly	Display unit	Periodically clean the exterior of display unit using dry soft clean. Use of commercially available CRT cleaner (spray) having antistatic effect is recommended.	CRT screen produces static charge which would attract dust. DO NOT use strong solvent like paint thinner or abrasive cleaners for cleaning. Dust and dirt on CRT creates symptoms similar to poor sensitivity.

*(Continued on next page)*

Interval	Check point	Check and measures	Remarks
3 to 6 months	Exposed nuts and bolts on antenna unit	Check for corroded or loosened nuts and bolts. If necessary, clean and repaint them thickly. Replace them if heavily corroded.	Sealing compound may be used instead of paint. Apply a small amount of grease between nuts and bolts for easy removal in future.
	Antenna radiator	Check for dirt and cracks on radiator surface. Thick dirt should be wiped off with soft cloth dampened with fresh water. If a crack is found, apply a slight amount of sealing compound or adhesive as a temporary remedy, then call for repair.	Do not use plastic solvent (acetone) for cleaning. If you need to remove ice from antenna unit, use a wooden hammer or plastic head hammer. Crack on the unit may cause water ingress, causing serious damages to internal circuits.
	Terminal strips and plugs in antenna unit	Open antenna cover to check terminal strip and plug connections inside. Also check the rubber gasket of antenna covers for deterioration.	When closing antenna covers in position, be careful not to catch loose wires between covers and unit.
6 months to one year	CRT and surrounding components	High voltage at CRT and surrounding components attract dust in environment which will cause poor insulation. Ask your nearest FURUNO representative or dealer to clean internal high-voltage components.	If CRT anode rubber cap or wire sheath is cracked, ask your dealer to replace it. Wait for at least 3 minutes until high voltage components (CRT and HV capacitors) discharge their residual charges before accessing them.
	Terminal strips, sockets, earth terminal	Check for loose connections. Check contacts and plugs for proper seating, etc.	

## 4.2 Life Expectancy of Major Parts

Part	Type	Life expectancy	Remarks
Antenna motor	RM-8123 (X-band) RM-8124 (X-band) RM-8247 (X-band) RM-7398 (S-band) RM-7435 (S-band) RM-9519 (S-band) RM-9520 (S-band) RM-9521 (S-band)	Gears more than 10,000 hours	Wind load 100 knots
Magnetron	MG5241 (X-band 10 kW) 9M752/M5187F (X-band, 25 kW) MG5223F (S-band, 30 kW) MG5240 (S-band, 60 kW)	2,000-3,000 hours	



# 5. TROUBLESHOOTING

## DANGER



### **DANGER: Electrical Shock Hazard**

This equipment contains high voltages which can cause death at several internal circuits including a cathode ray tube (CRT) which uses several thousand volts. Any internal adjustment, servicing and repair shall only be performed by qualified service personnel totally familiar with electrical circuits and servicing of the equipment. A residual charge remains in capacitors and other devices several minutes after turning off the power. It is therefore essential to wait at least 3 minutes to allow residual charge to subside before accessing the inside of the equipment. Special care must be taken when approaching the following parts:

- Power supply circuit (Display unit and separate power supply units)
- CRT circuit (Display unit)
- Modulator circuit and magnetron (Antenna unit or separate transceiver unit)
- Motor drive circuit (Antenna unit)

## WARNING



### **WARNING: When Working on the Antenna Unit**

Wear a safety belt and a hard hat when working on the antenna unit. Always make sure that the radar is POWERED OFF and the Antenna switch in the display unit is OFF before working on the antenna unit. Also take all steps to ensure that the radar will not be accidentally operated by someone else, to prevent the potential risk of being struck by the rotating antenna and exposure to RF radiation hazards.

## 5.1 Easy Troubleshooting

This paragraph describes how to cure operational problems, which can be made by observing the radar picture and using operator controls and keys without opening the display unit, antenna unit or other equipment units.

The table below shows user-level troubleshooting procedures.

<b>Problem</b>	<b>Remedy</b>
Key beep inaudible	Adjust key beep level on RADAR 2 menu referring to paragraph 1.32.
No own ship mark	On the R-type radar, check that SHIP'S MARK ON is selected at the RADAR 2 menu, referring to paragraph 1.32. Also, own ship information (length, width, etc.) should have been entered in initial settings. Consult a FURUNO representative or dealer for details. On the IMO type, the own ship mark is not available.

## 5.2 Advanced-level Troubleshooting

This paragraph describes how to cure hardware and software troubles which should be carried out by qualified service personnel.

**Note:** This radar equipment contains complex modules in which fault diagnosis and repair down to component level are not practicable by users.

### Serviceman qualification

All adjustments of radio transmitter during or coinciding with the installation, servicing, or maintenance which may affect the proper operation must be performed by or under the immediate supervision and responsibility of a

person holding an operator certificate containing a ship radar endorsement.

This is what the U.S. Codes of Federal Regulations part 80.169 implies (not exact extract).

As such, every administration sets forth its own rule; service personnel must be aware of this kind of competency requirements.

### Service call

When making a service call to your service agent, check S/N and symptom beforehand.

Problem	Check point and probable cause	Remedy
Power turned on but radar does not operate at all. Control panel is not illuminated either.	<ol style="list-style-type: none"> <li>1. Blown fuse F1 or F2</li> <li>2. Mains voltage/polarity</li> <li>3. Power Supply Board</li> <li>4. Illumination lamps</li> </ol>	<ol style="list-style-type: none"> <li>1. Replace blown fuse.</li> <li>2. Correct wirings and input voltage.</li> <li>3. Replace Power Supply Board.</li> <li>4. Replace defective lamps.</li> </ol>
CRT brilliance adjusted but no picture	<ol style="list-style-type: none"> <li>1. RADAR 1/2 menu settings</li> <li>2. CRT voltage</li> <li>3. SPU Board</li> </ol>	<ol style="list-style-type: none"> <li>1. In case of single display installation without radar inter-switching), make sure RADAR 1 is selected on SYSTEM SETTING menu.</li> <li>2. Check high voltage supply with utmost care.</li> <li>3. Replace SPU Board.</li> </ol>
Antenna not rotating	<ol style="list-style-type: none"> <li>1. Antenna drive mechanism (Note that the message BRG SIG MISSING appears in stand-by.)</li> <li>2. Defective antenna drive motor relay (thermal relay K2, 200/220/380, 440/100VAC)</li> <li>3. INT-9170 Board</li> </ol>	<ol style="list-style-type: none"> <li>1. Make sure that there is no short circuit across #1 and #2 of J461 on IN-9170 Board.</li> <li>2. Press relay reset button.</li> <li>3. Check that antenna switch is on.</li> </ol>
Alphanumeric data and marks are not displayed in Transmit status.	<ol style="list-style-type: none"> <li>1. SPU Board</li> </ol>	<ol style="list-style-type: none"> <li>1. Replace SPU Board.</li> </ol>

<b>Problem</b>	<b>Check point and probable cause</b>	<b>Remedy</b>
Adjust GAIN control with A/C SEA control set at minimum. Marks and legends appear but no noise or echo.	<ol style="list-style-type: none"> <li>1. IF amplifier</li> <li>2. Signal cable between antenna and display</li> <li>3. Video Amplifier Board</li> </ol>	<ol style="list-style-type: none"> <li>1. Replace IF amplifier.</li> <li>2. Check continuity and isolation of coaxial cable. (Note: Disconnect the plug and lugs at both ends of coaxial cable before checking it by ohmmeter.)</li> <li>3. Check video coax line for secure connection. If connection is good, replace SPU Board.</li> </ol>
Marks, legends and noise appear but no echo. (Transmission leak, representing own ship position, is absent.)	<ol style="list-style-type: none"> <li>1. Tx fuse F801 (Trans. Unit)</li> <li>2. Magnetron</li> <li>3. Modulator Board</li> <li>4. SPU Board</li> </ol>	<ol style="list-style-type: none"> <li>1. If fuse is blown, replace it. If it blows again, the modulator or modulator circuit may be defective.</li> <li>2. Check magnetron current with the check meter in the sub panel. Replace magnetron.</li> <li>3. Replace Modulator Board.</li> <li>3. Replace SCR. DANGER: HIGH VOLTAGE.</li> <li>4. Replace SPU Board.</li> </ol>
Picture not updated	<ol style="list-style-type: none"> <li>1. Bearing Signal Generator Board (antenna unit)</li> <li>2. SPU Board</li> <li>3. Video lockup</li> </ol>	<ol style="list-style-type: none"> <li>1. Check the connection of signal cable.</li> <li>2. Replace SPU Board.</li> <li>3. Turn off and on radar.</li> </ol>
Incorrect orientation of picture	<ol style="list-style-type: none"> <li>1. SPU Board</li> <li>2. Gyro Interface</li> </ol>	<ol style="list-style-type: none"> <li>1. The message "HD SIG MISSING" appears when the heading pulse is not received during stand-by.</li> <li>2. Replace gyro interface.</li> </ol>
TUNE control adjusted but poor sensitivity	<ol style="list-style-type: none"> <li>1. Deteriorated magnetron</li> <li>2. Detuned MIC</li> <li>3. Dirt on radiator face</li> <li>4. Water ingress to the wave-guide or other feeder line</li> <li>5. Second trace rejection is ON.</li> </ol>	<ol style="list-style-type: none"> <li>1. With radar transmitting on 48 mm range, check magnetron current. If current is below normal value, magnetron may be defective. Replace magnetron.</li> <li>2. Check MIC detecting current. If it is below normal value, MIC may have become detuned. MIC must be tuned.</li> <li>3. Clean radiator surface.</li> <li>4. Remove water from the feeder line.</li> <li>5. Disable the second-trace rejector referring to paragraph 1.36.</li> </ol>
Range changed but radar picture does not change	<ol style="list-style-type: none"> <li>1. Defective RANGE key</li> <li>2. SPU Board</li> <li>3. Mother Board</li> <li>4. Video lockup</li> </ol>	<ol style="list-style-type: none"> <li>1. Try to hit [+] and [-] RANGE keys several times. If unsuccessful, replacement of keypad may be required.</li> <li>2. Replace SPU Board.</li> <li>3. Replace Mother Board.</li> <li>4. Turn off and on radar.</li> </ol>

<b>Problem</b>	<b>Check point and probable cause</b>	<b>Remedy</b>
Interference rejector inoperable (interference rejection level not displayed)	1. Bad contact of key 2. SPU Board 3. Mother Board	1. Repair contact of key. 2. Replace SPU Board. 3. Replace Mother Board.
Echo stretch ineffective (Neither "ES1" nor "ES2" is displayed.)	1. Bad contact of key 2. SPU Board	1. Repair contact of key. 2. Replace SPU Board.
Only 2 parallel index lines (6 lines wanted)	1. Incorrect setting of index line interval	1. Set index line interval referring to paragraph 1.26.
Range rings are not displayed.	1. Press RINGS key to see if intensity is increased. control to see if intensity is increased. 2. Bad contact of key 3. SPU Board	1. Replace associated circuit board if unsuccessful.  2. Replace keypad. 3. Replace SPU Board.
Key beep inaudible	1. Improper setting on RADAR 2 menu	1. Adjust key beep level on RADAR 2 menu referring to paragraph 1.32.
Poor discrimination at range	1. Sea clutter control not functioning properly.	1. Improper setting of A/C SEA control. If A/C SEA is seen only at very close range, suspect inaccurate frequency of crystal oscillator.
True motion presentation not working correctly	1. Poor contact of MODE key. 2. Selection is not accessed.  3. Speed entry is incorrect.  4. TM display inaccurate	1. Try to press MODE key a little harder. 2. Press MODE key until "TM" appears. 3. Enter correct own ship speed referring to paragraph 1.24. 4. Make sure that speed and compass inputs are accurate.
Target not tracked correctly	1. Poor definition of targets in sea clutter	1. Adjust A/C SEA and A/C RAIN controls referring to paragraphs 1.13 and 1.14.

### 5.3 Diagnostic Test

A diagnostic test program is provided to enable testing of major circuit boards in the radar display unit. Note that the normal radar picture is lost during this test.

Proceed as follows to execute the diagnostic test:

1. Press the RADAR MENU key on the plotting keypad to show the FUNCTIONS menu.
2. Press numeric key [0][0] to show the SYSTEM SETTING 2 menu.
3. **On the R-type**, press the key [3] to select menu item 3TEST . Then, press the ENTER key.

**On the IMO-type**, press the key [3] to select menu item 3TEST . Then, press numeric key [3] again to highlight select TEST ON, followed by the ENTER key.

Now, the diagnostic test is executed and the screen shows test results as shown on the next page.

4. To terminate the diagnostic test, turn off the power switch. Perform "quick start" (see page 1-1) if you wish to restore normal radar operation immediately.

Small squares displayed at the right and bottom of the test result screen are for testing the switches and keys in the hinged compartments of the display unit and on the operator control panel. As you operate these switches and keys, corresponding squares are highlighted, indicating that your switch/key operations are properly recognized.

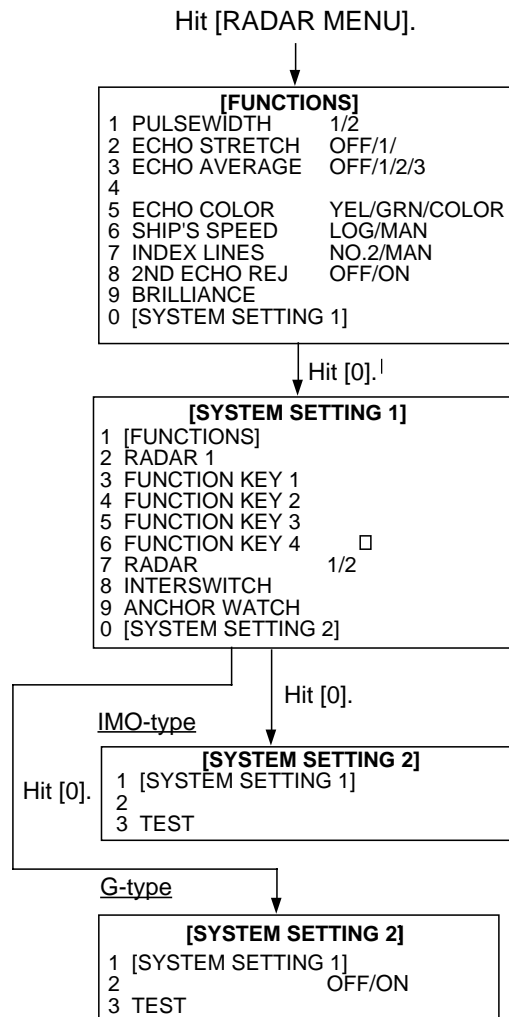

FR-2005 TEST

```

PROGRAM NO      ROM RAMCRAM DIPSW
MAIN XXXXXXXXXXXX OK  OK  OK  1111
SUB  XXXXXXXXXXXX OK  OK
ARP  XXXXXXXXXXXX OK  OK  OK  0000
DSP  XXXXXXXXXXXX OK  OK  OK
RP   XXXXXXXXXXXX OK  OK  OK  1000
DRAM
RP  BOARD BAT OK
RP  CARD1 OK  CARD2  OK
VRAM 1 2 3 4 5 6 7 8
    
```

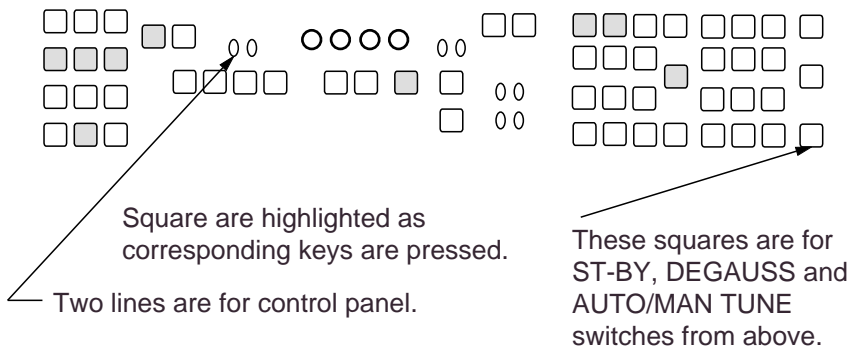

## A.1 Performance Monitor

For X-band radars, the FURUNO PM-30 satisfies the requirement covering  $9410 \pm 50$  MHz. For S-band radars, the PM-50 is available covering  $3050 \pm 30$  MHz.

The performance monitor is an independent unit, namely, it is not interconnected with any unit of the radar system except for the 100 VAC power cable. In some radars the power cable is not routed via the power switch or other control of the radar and the monitor is operated as completely a separate device.

### Operating the performance monitor

When Radar Interswitch RJ-7 is connected, set it to the "straight" mode. Press the PM ON/OFF button at the lower left corner in the Turning Compartment, and the range scale is automatically set to 24 nm range scale, producing the monitor display. The radar screen will show several arcs, opposite to the heading marker (provided that the performance monitor is installed behind the radar antenna as is normally the case). If the radar transmitter and receiver are in good working conditions in as much as the original state when the monitor was turned up, the innermost arc should appear at 12 nm and there should be a total of 4 arcs.

The range of the innermost arc reduces 3 nm with every 3 dB loss of transmitted power. The receiver sensitivity can be evaluated from the number of visible arcs; one arc is lost every 3 dB deterioration of the sensitivity.

Transmitter performance		Receiver performance	
Range to innermost arc	Loss	No. of arcs	Loss
12 nm	0 dB	4	0 dB
9 nm	3 dB	3	3 dB
6 nm	6 dB	2	6 dB
3 nm or less or none	10 dB	1	9 dB
		0	12 dB

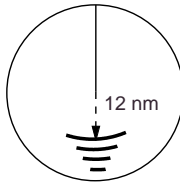
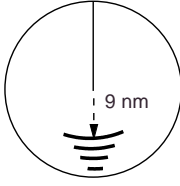
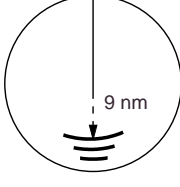
Display	Meaning
	TRANSMITTER: normal RECEIVER: normal
	TRANSMITTER: 3 db loss (Transmitter system has lost half of initial power. Suspect magnetron and feeder system.) RECEIVER: normal
	TRANSMITTER: 3 db loss (Transmitter system has lost half of initial power. Suspect magnetron and feeder system.) RECEIVER: 3 db loss (Receiver has lost half of normal sensitivity. Suspect receiver front end, water leakage in feeder system, etc.)

## A.2 For Fishing Vessel

This radar can be customized as a fishing vessel version with an internal setting. The fishing vessel version offers an additional picture setup option "BIRD," which is assignable to one of the function keys depending on a setting on FUNCTION KEY 1, 2, 3 or 4 menu shown below.

If the BIRD option is menu-selected at the time of installation, the corresponding function key is labeled "BIRD." Press the function key "BIRD" and the radar will be set for optimum detection of sea birds between 6 and 16 nm. As is well known by professional fishermen, locating a flock of sea birds is useful for finding certain species of fish.

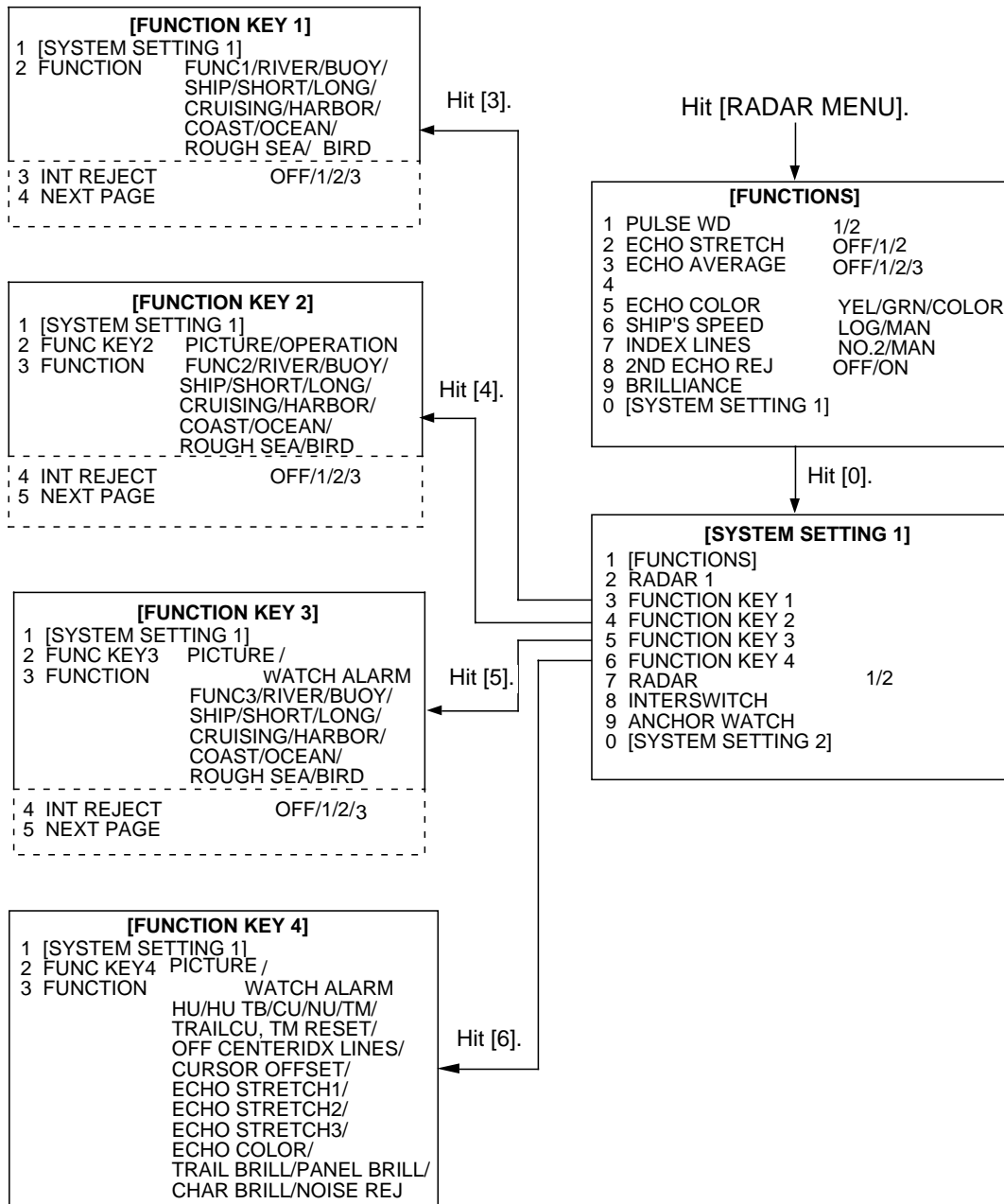

**Note:** Items enclosed by dashed lines should be left in the default settings. For further information, contact a FURUNO representative.



## **A.3 Navigation Data (IEC 61162-1 Edition 1 and Edition2)**

### **1. I/O Sentences for Channel 1**

#### **Input**

BWC, BWR, DBT, DPT, GGA, GLL, MTW, MWV, RMA, RMB, RMC, VDR, VTG(\*),  
ZDA \*: not recommended in IMO-type

### **2. I/O Sentences of Channel 2**

#### **Input**

VBW, VHW, HDT

#### **Output**

RAOSD, RARSD (An interval of three seconds)

### **3. I/O Sentences of Channel 3**

#### **Output**

RATTM (Every five seconds when acquiring 10 targets)

### **4. Sentence Description**

See pages which follow.

Note: Checksum for RMA, RMB, and RMC is mandatory. Checksum for other sentences is evaluated if it exists.

### **5. Priority**

Nav data sentences below are read left to right, and in case of timeout the sentence right of last read sentence is read. In case of multiple high priority sentences the sentences having the highest priority is read. \*\* is read regardless of talker. Timeout is 30 seconds unless specified otherwise. Difficult time-outs for data sentences are required by German authorities.

#### **Position data**

GP GGA>GPRMC>GP GLL>LCRMA>LC GLL>\*\* GLL

Timeout: 30 seconds

## **Data, time data**

GPZDA

Timeout: 10 seconds

## **Course heading, speed over ground**

**(In the case of log)**

VDVBW>\*\*VBVBW

**(In the case of navigator)**

GPVTG>GPRMC (Not recommended in IMO-type)

## **Course heading, speed over water**

VDVBW>\*\*VBW>VD VHW

## **Water depth data**

SDDPT>SDDBT>\*\*DBT>\*\*DBS

## **Water temperature data**

\*\*MTW

## **Waypoint range and bearing data**

GPBWR>GPBWC>GPRBM

## **Route data (WPL, RTE)**

\*WPL

\*RTE

## **Ship's heading**

\*\*HDT

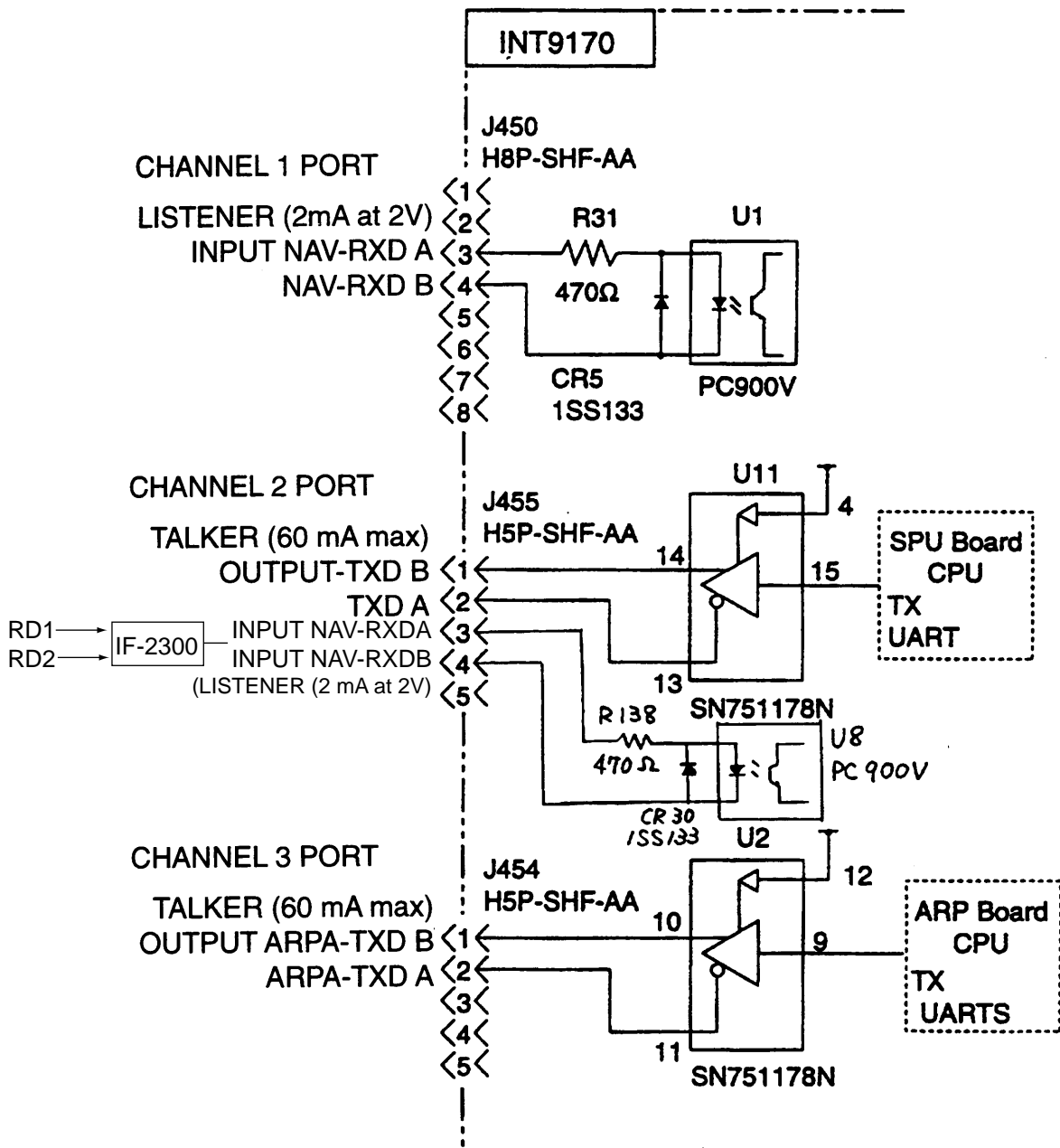

# SIMPLIFIED INTERCONNECTION DIAGRAM

(See Installation Manual for terminal connection)

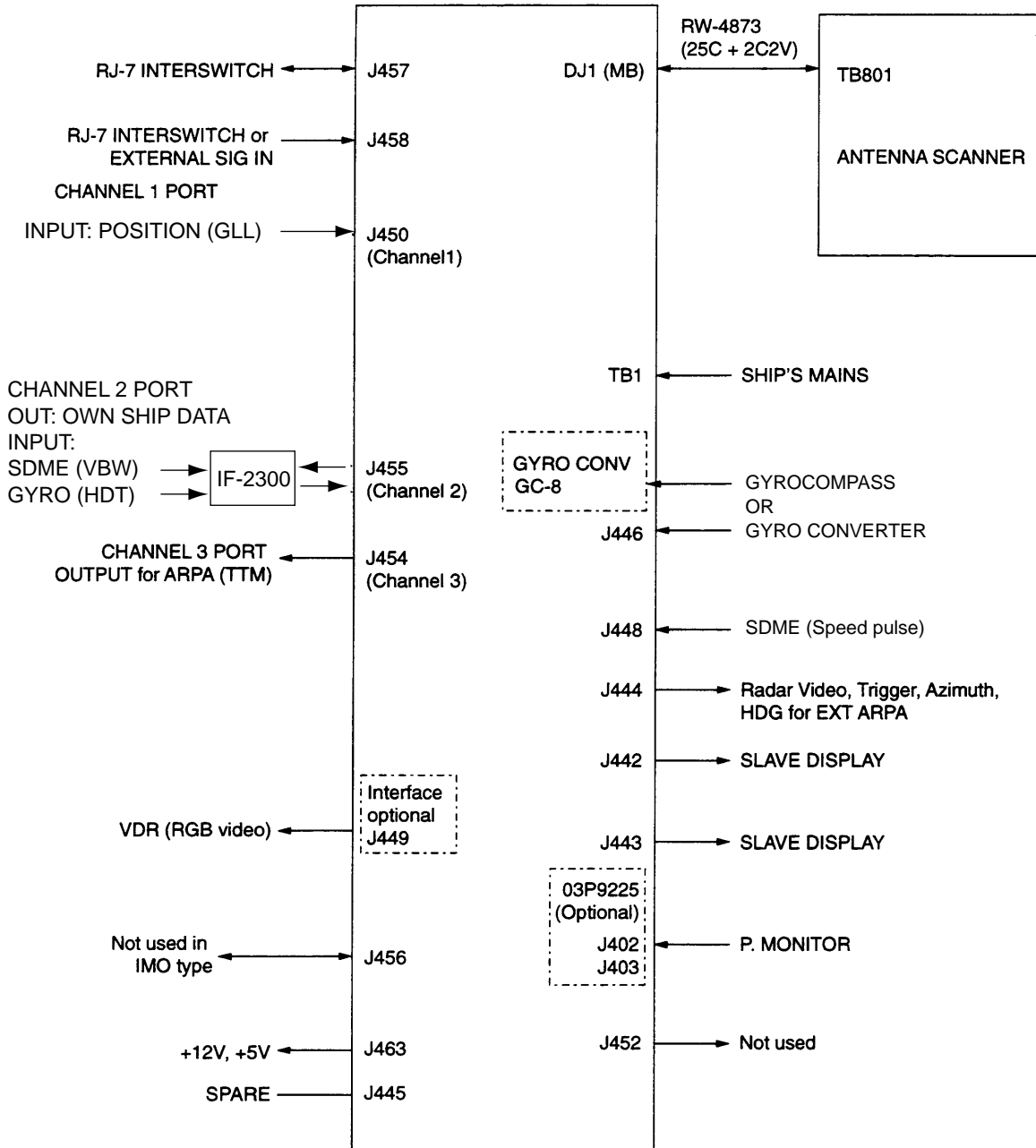

Note: The FR/FAR-2805 does not process the IEC61162-2 data. Therefore, the system may only work as HSC radar by receiving gyro compass data thru GC-8 or AD-100.

## A.4 Sentence Description

### Channel 1 Input

#### BWC - Bearing and distance to waypoint - great circle

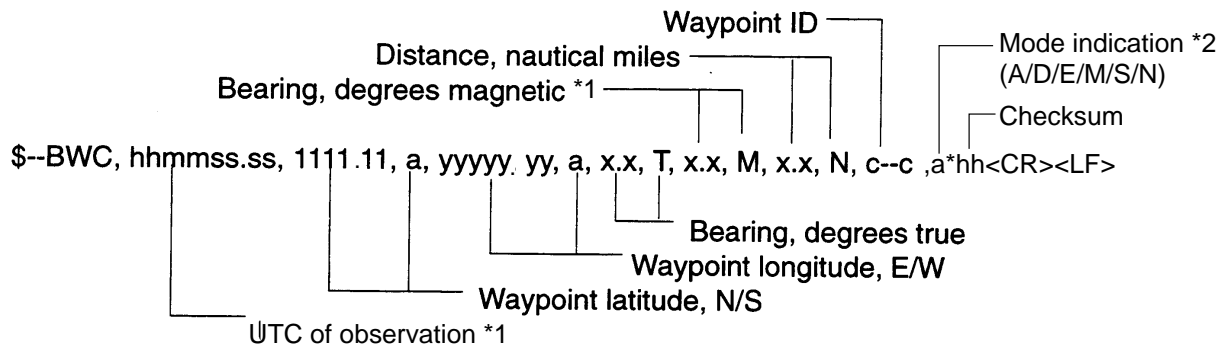

\*1 Not used

\*2 Edition 2 only

#### BWR - Bearing and distance to waypoint - rhumb line

Time (UTC) and distance and bearing to, location of, a specified waypoint from present position.

\$--BWR data is calculated along the rhumb line from present position rather than along the great circle path

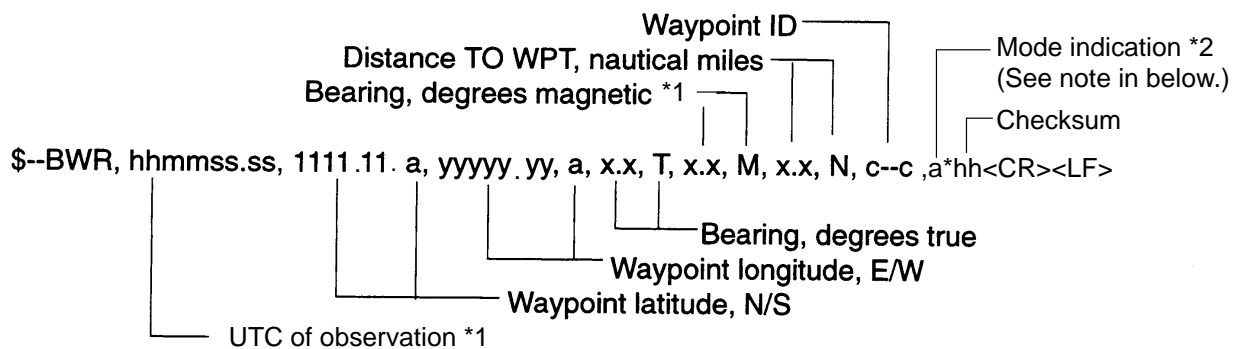

\*1 Not used

\*2 Edition 2 only

Note: The mode indicator character "a" has been defined as follows:

A= Autonomous mode

D= Differential mode

E= Estimated (dead reckoning) mode

M= Manual input mode

S= Simulator mode

N= Data not valid

### DBT - Depth below transducer

Water depth referenced to the transducer.

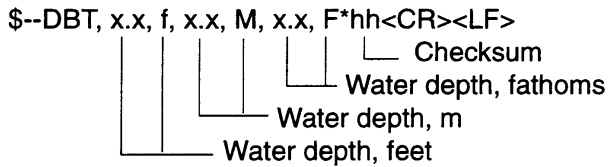

Priority: f > M > F

### DPT - Depth

IMO Resolution A.224 (VII). Water depth relative to the transducer and offset of the measuring transducer. Positive offset numbers provide the distance from the transducer to the waterline. Negative offset numbers provide the distance from the transducer to the part of the keel of interest.

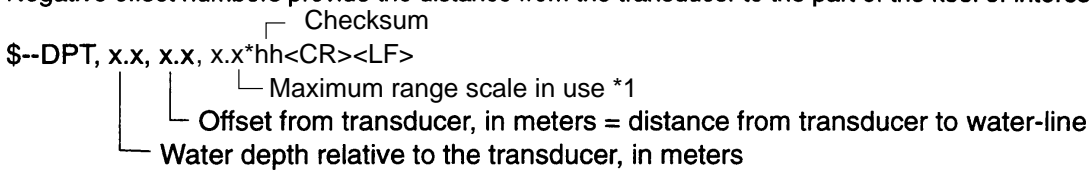

\*1 Edition 2 only, not used.

### GGA - Global positioning system (GPS) fix data

Time, position and fix related data for a GPS receiver.

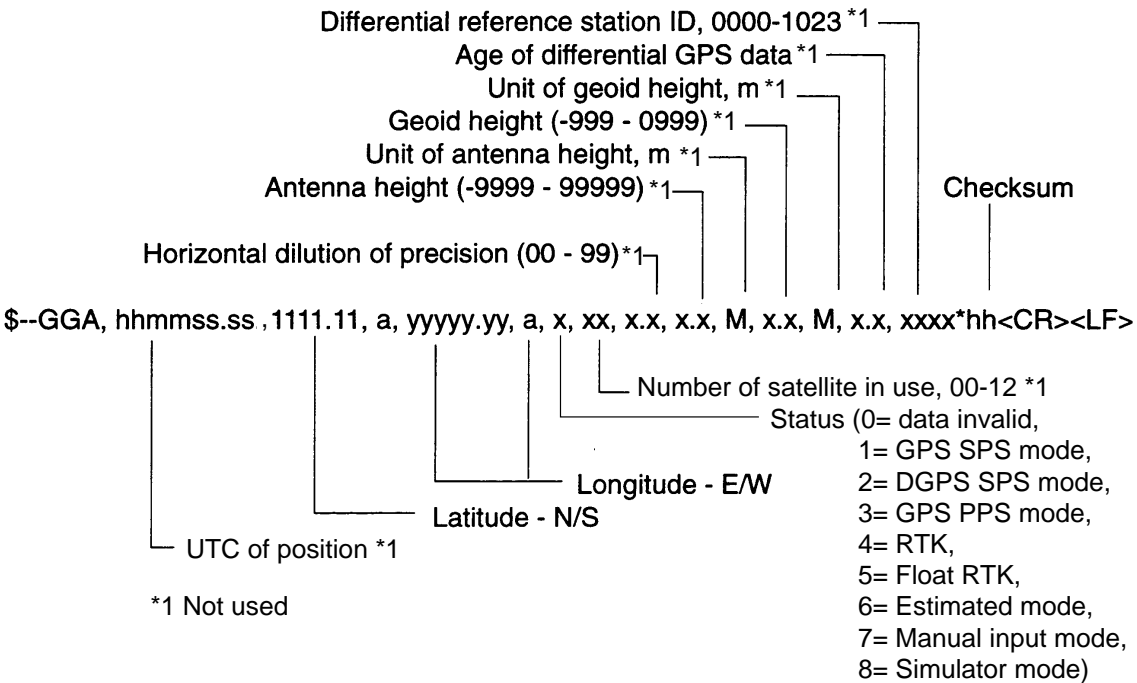

### GLL - Geographic position - latitude/longitude

Latitude and longitude of vessel position, time of position fix and status.

\$--GLL, 1111.11, a, yyy.yy, a, hhmmss.ss, A, a\*hh<CR><LF>

Mode indicator (See note on page A-7.) \*2  
Checksum  
Status (A = data valid V = data invalid)  
UTC of position \*1  
Longitude, E/W  
Latitude, N/S

\*1 Not used

\*2 Edition 2 only

### MTW - Water temperature

\$--MTW, x.x, C\*hh<CR><LF>

Checksum  
Temperature, degrees C (99.9 to - 99.9 °C)  
Display range: 99.9 to - 99.9 °C

### MWV - Wind speed and angle

When the reference field is set to relative, data is provided giving the wind angle in relation to the vessel's heading and wind speed, both relative to the moving vessel.

When the reference field is set to true, data is provided giving the wind angle relative to the vessel's heading and wind speed, both with reference to the moving water. True wind is the vector sum of the relative apparent wind vector and the vessel's velocity vector along the heading line of the vessel. It represents the wind at the vessel if it were stationary relative to the water and heading in the same direction.

\$--MWV, x.x, a, x.x, a, A\*hh<CR><LF>

Checksum  
Status (A = data valid V = data invalid)  
Wind speed unit (K/M/N)  
Wind speed  
Reference, R = relative  
T = true  
Wind angle (0 to 359.9 degrees)

## RMA - Recommended minimum specific LORAN-C data

Position, course and speed data provided by a LORAN-C receiver. Time differences A and B are those used in computing latitude/longitude. Checksum is mandatory in this sentence. This sentence is transmitted at intervals not exceeding 2 s and is always accompanied by RMB when a destination waypoint is active. RMA and RMB are the recommended minimum data to be provided by a LORAN-C receiver. All data fields must be provided, null fields used only when data is temporarily unavailable.

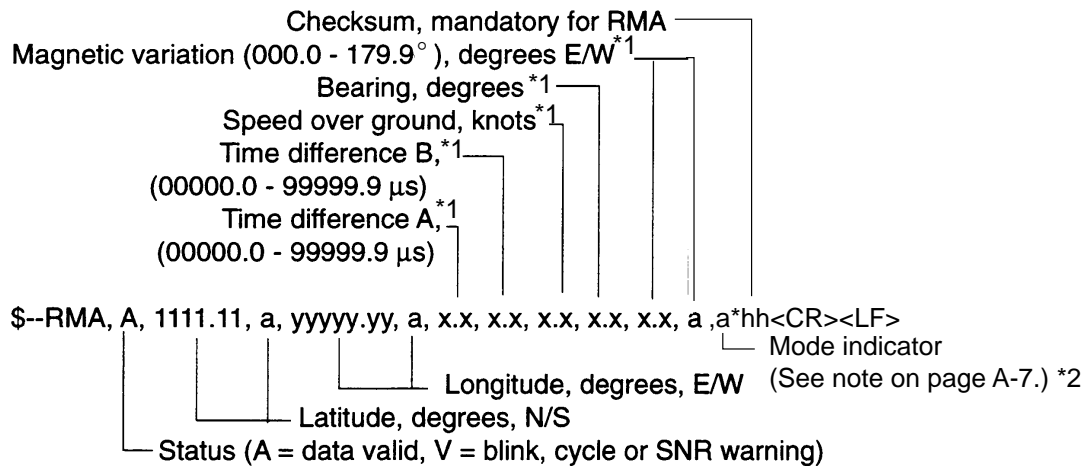

\*1 Not used

\*2 Edition 2 only

## RMB - Recommended minimum navigation information

Navigation data from present position to a destination waypoint provided by a LORAN-C, TRANSIT, OMEGA, GPS, DECCA, navigation computer or other integrated navigation system. Checksum is mandatory in this sentence. This sentence always accompanies RMA or RMC sentences when a destination is active when provided by a LORAN-C, TRANSIT or GPS receiver, other systems may transmit \$--RMB without \$--RMA or \$--RMC.

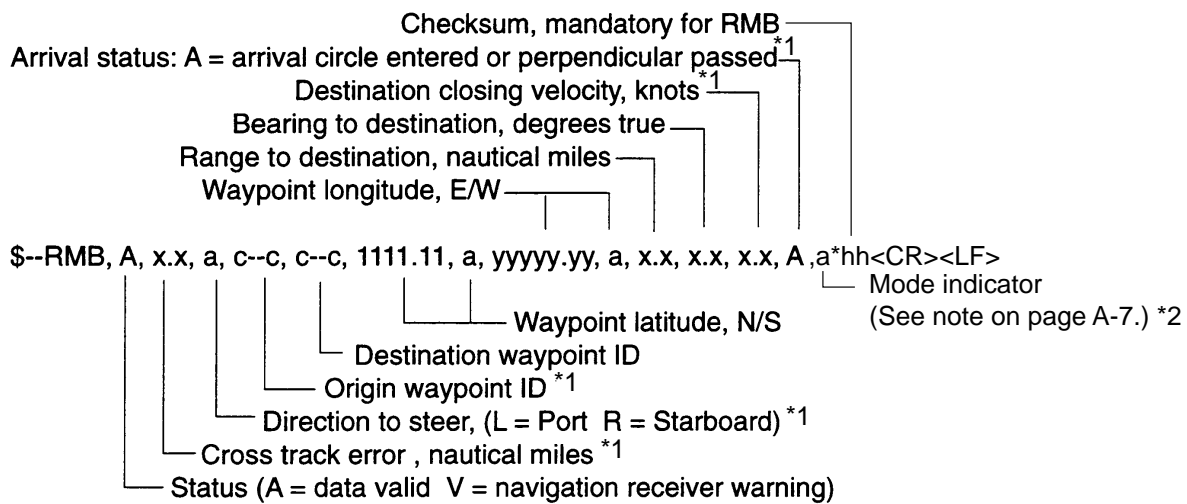

\*1 Not used

\*2 Edition 2 only



## RMC - Recommended specific GPS/TRANSIT data

Time, date, position, course and speed data provided by a GPS or TRANSIT navigation receiver. Checksum is mandatory in this sentence. This sentence is transmitted at intervals not exceeding 2 s and is always accompanied by RMB when a destination waypoint is active. RMC and RMB are the recommended minimum data to be provided by a GPS or TRANSIT receiver. All data fields must be provided, null fields used only when data is temporarily unavailable.

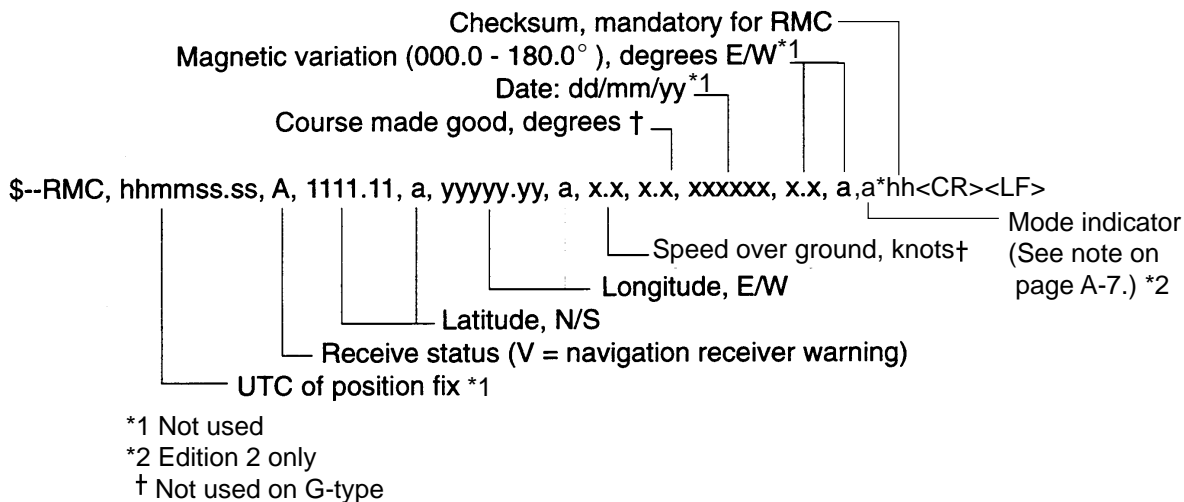

## RTE - Routes

Waypoint identifiers, listed in order with starting waypoint first, for the identified route. Two modes of transmission are provided: "c" indicates that the complete list of waypoints in the route is being transmitted; "w" indicates a working route where the first listed waypoint is always the last waypoint that had been reached (FROM), while the second listed waypoint is always the waypoint that the vessel is currently heading for (TO), the remaining list of waypoints represents the remainder of the route.

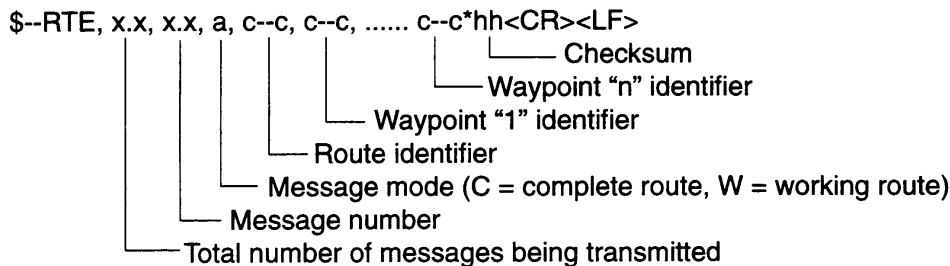

### VDR - Set and drift

The direction towards which a current flows (set) and speed (drift) of current.

\$--VDR, x.x, T, x.x, M, x.x, N \*hh<CR><LF>

\*1 Not used

### VTG - Course over ground and ground speed (R-TYPE ONLY)

The actual course and speed relative to the ground.

\$--VTG, x.x, T, x.x, M, x.x, N, x.x, K ,a\*hh<CR><LF>

\*1 Not used

\*2 Edition 2 only

### WPL - Waypoint location

Latitude and longitude of specified waypoint

\$--WPL, 1111.11, a, yyyyy.yy, a, c--c\*hh<CR><LF>

### ZDA - Time and date

UTC, day, month, year and local time zone.

\$--ZDA ,hhmmss.ss, xx, xx, xxxx, xx, xx\*hh<CR><LF>

\*1 Not used

## Channel 2 input

### VBW - Dual ground/water speed

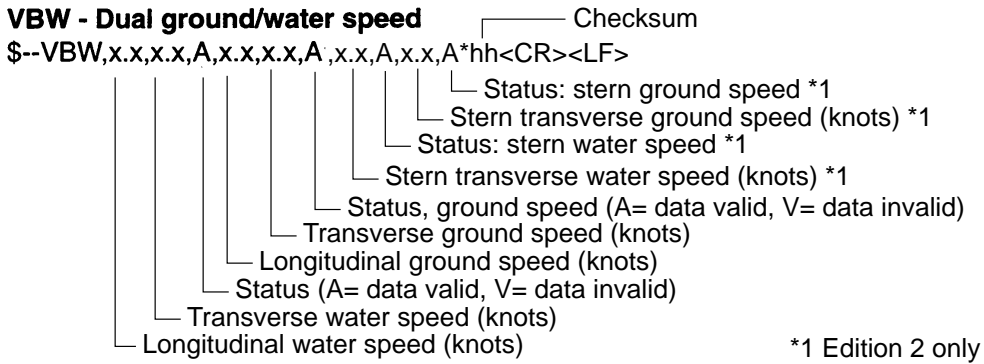

### VHW - Water speed and heading

The compass heading to which the vessel points and the speed of the vessel relative to the water.

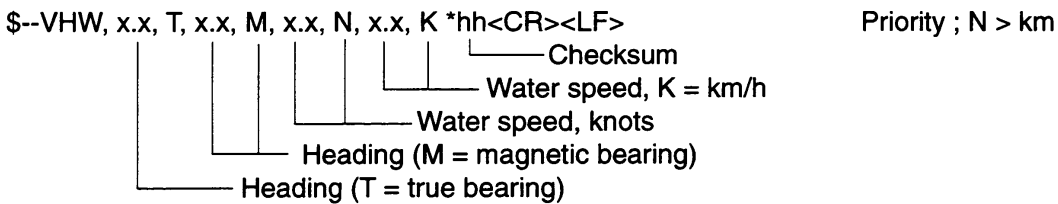

### HDT - Heading - true

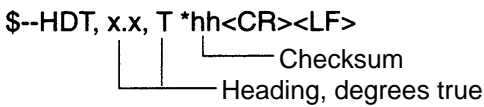

## Channel 2 output

### OSD - own ship data

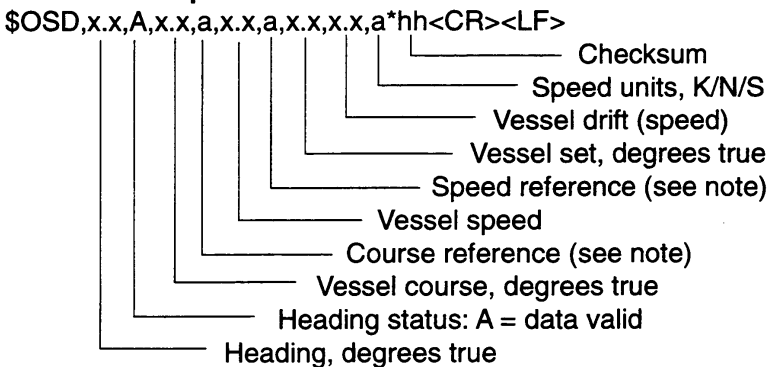

Note - Reference systems (speed/course)

- B = bottom tracking log
- M = manually entered
- W = water referenced
- R = radar tracking (of fixed target)
- P = positioning system ground reference



## Channel 3 output

### TTM - Tracked target message

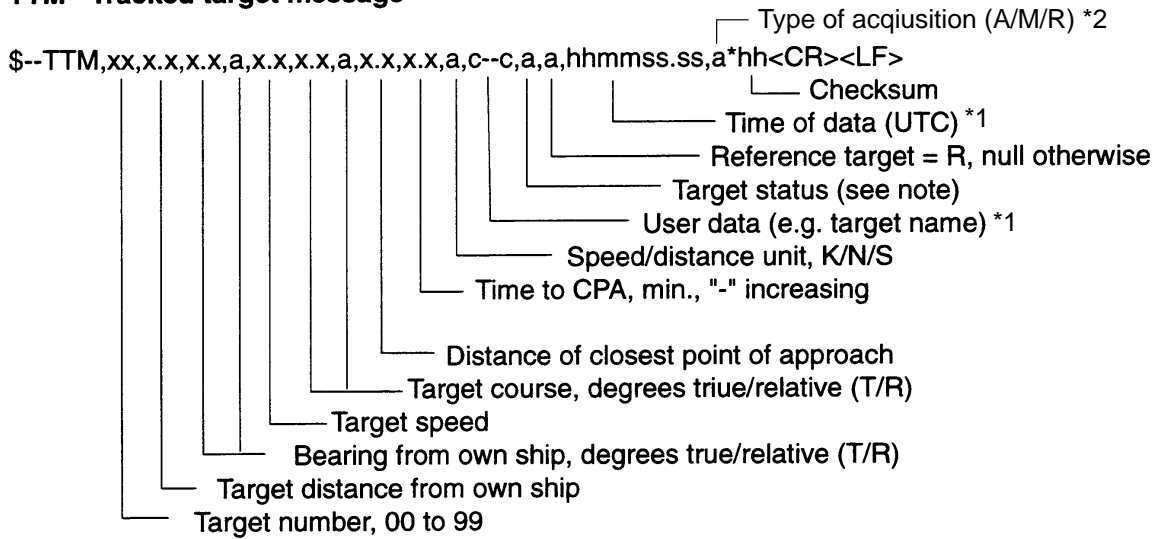

#### Note Target status:

- L = lost, tracked target has been lost
- Q = query, target in the process of acquisition
- T = tracking

\*1 Not used

\*2 Edition 2 only

# MENU TREE

## MAIN MENU

### FUNCTIONS 1

- 1. PULSE WIDTH (1, 2)
- 2. ECHO STRETCH (OFF, 1, 2)
- 3. ECHO AVERAGE (OFF, 1, 2, 3)
- 4. PANEL DIMMER (OFF, DIM, M, BRT)
- 5. ECHO COLOR (YEL, GRN, COLOR\*)
- 6. SHIP SPEED (LOG, NAV\*, MAN)
- 7. INDEX LINES (No.2 VRM, MAN)
- 8. SET/DRIFT (OFF, MAN)
- 9. BRILLIANCE
- 0. FUNCTIONS 2

\*: R-type only

- 1. FUNCTIONS 1
- 2. CHAR BRILL (DIM, M1, M2, BRT)
- 3. MARKS BRILL (DIM, M1, M2, BRT)
- 4. TRAIL BRILL (DIM, M1, M2, BRT)
- 5. +CURSOR BRILL (DIM, M, BRT)
- 6. PLOT BRILL (OFF, DIM, M, BRT)
- 7. HDG MARK BRILL (DIM, M, BRT)
- 9. SYMBOL GRID BRILL (DIM, M1, M2, BRT)
- 0. CHART BRILL (DIM, M1, M2, BRT)

### FUNCTIONS 2

- 1. FUNCTIONS 1
- 2. RADAR 1
- 3. FUNCTION KEY 1
- 4. FUNCTION KEY 2
- 5. FUNCTION KEY 3
- 6. FUNCTION KEY 4
- 7. RADAR (1, 2)\*
- 8. ANCHOR WATCH
- 9. INTER SWITCH (Requires RJ-7 or 8)
- 0. FUNCTIONS 3

- 1. FUNCTIONS 2
- 2. ANCHOR WATCH (OFF, ON)
- 3. ALARM (OFF, ON)
- 4. ALARM RANGE (x.xxx NM)
- 5. HISTORY (OFF, ON)

### FUNCTIONS 3

- 1. FUNCTIONS 2
- 2. INITIAL SETTING (Avalable by special operation)
- 3. TEST

### RADAR 1

- 1. FUNCTIONS 2
- 2. EBL1 (REL, TRUE)\*
- 3. EBL2 (REL, TRUE)\*
- 6. TRAIL (REL, TRUE)
- 7. TRAIL GRAD (SGL, MULT)
- 8. [PULSE WD 1]
- 9. [PULSE WD 2]
- 0. RADAR 2

### RADAR 2

- 1. RADAR 1
- 2. CURSOR, EBL (REL, TRUE)
- 3. NOISE REJ (OFF, ON)
- 4. STERN MARK (OFF, ON)\*
- 5. SHIP'S MARK (OFF, ON)
- 6. GUARD ALARM (IN, OUT)\*
- 7. KEY BEEP (L, M, H)\*
- 8. AUDIO ALARM (L, M, H)
- 9. RADAR NO. (1, 2)

# FUNCTION KEY MENU

## FUNCTION KEY 1

- 1. FUNCTIONS 2
- 2. FUNCTION (FUNC1, RIVER, BUOY, SHIP, SHORT, LONG, CRUISING, HARBOR, COAST, OCEAN, ROUGH SEA)
- 3. INT REJECT (OFF, 1, 2, 3)
- 4. ECHO STRETCH (OFF, 1, 2)
- 5. ECHO AVERAGE (OFF, 1, 2, 3)
- 6. A/C AUTO (OFF, ON)
- 7. FUNC 1 PULSE WD
- 8. NOISE REJ (OFF, ON)

- 1. FUNCTION KEY 1, 2 or 3
- 2. 0.5 NM (S1, S2)
- 3. 0.75 NM (S1, S2)
- 4. 1.5 NM (S1, S2, M1)
- 5. 3 NM (S1, S2, M1)
- 6. 6 NM (M1, M2, L)
- 7. 12-24 NM (M2, L)

## FUNCTION KEY 2, 3

- 1. FUNCTIONS 2
- 2. FUNC KEY 2 or 3 (PICTURE/OPERATION)
- 3. FUNCTION (FUNC2/3, RIVER, BUOY, SHIP, SHORT, LONG, CRUISING, HARBOR, COAST, OCEAN, ROUGH SEA)
- 4. INT REJECT (OFF, 1, 2, 3)
- 5. ECHO STRETCH (OFF, 1, 2)
- 6. ECHO AVERAGE (OFF, 1, 2, 3)
- 7. A/C AUTO (OFF, ON)
- 8. FUNC 2/3 PULSE WD
- 9. NOISE REJ (OFF, ON)

## FUNCTION KEY 4

- 1. FUNCTIONS 2
- 2. FUNC KEY 4 (OPERATION, WATCH ALARM)
- 3. ALARM INTERVAL (6, 10, 12, 15, 20 MIN)

- 1. FUNCTION2
- 2. FUNC KEY 2/3 (PICTURE/OPERATION)
- 3. OPERATION (HU, HU TB, CU, NU, TM, TRAIL; CU, TM RESET; OFF CENTER, IDX LINES, CURSOR OFFSET, ECHO STRETCH1, ECHO STRETRCH2, PLS WD1, PLS WD2, ECHO AVG1, ECHO AVG2, ECHO AVG3, ECHO COLOR, TRAIL BRILL, PANEL BRILL, CHAR BRILL, NOISE REJ, TARGET DATA, CANCEL)

# PLOT MENU

## ARPA 1

- 1. AUTO ACQ (OFF, ON)
- 2. AUTO ACQ AREA (3, 6 NM, SET)
- 3. GUARD ZONE (OFF, ON)
- 4. GUARD ZONE SET
- 5. REF TARGET VECT (OFF, ON)
- 6. CPA/TCPA WARNING (OFF, ON)
- 7. HISTORY DOTS (5, 10, 20)
- 8. HISTORY INTERVAL (30S, 1, 2, 3, 6 MIN)
- 9. AUDIO ALARM (ON, OFF)
- 0. ARPA 2

## EPA

- 1 CPA/TCPA WARNING (OFF, ON)  
CPA 0.0NM  
TCPA 00.0 MIN
- 2 MARK SIZE (STD, LARGE)
- 3 PLOT NO. (OFF, ON)
- 4 REL VECT TGT DATA (REL, TRUE)
- 5 AUDIO ALARM (OFF, ON)

- 1. ARPA 1
- 2. TRAIL MODE (STATIC, DYNAMIC)
- 3. MARK SIZE (STANDARD, LARGE)
- 4. DISPLAY BCR/BCT (OFF, ON)
- 5. ZET VECT TGT DATA (REL, TRUE)
- 6. GZ/AZ STABILIZED (NORTH, CRT)
- 7. SPEED REF (WT, BT)\*
- 8. INPUT SIG CHECK
- 9. ARP TRACK TEST
- 0. ARP INITIAL SETTING

## NAV

### NAV INFORMATION 1

- 1. RADAR MAP
  - 2. SELECT NAV AID (GPS+LC, DEAD RECKONING)
  - 3. OWN SHIP POSN (OFF, L/L)
  - 4. POSN
  - 5. +CURSOR DATA (OFF, L/L)
  - 6. WPT DATA (OFF, REL\*, TRUE\*)
  - 7. WAY POINT
  - 8. NAV LINE
  - 9. WIND DATA (OFF, ON)
  - 0. NAV INFORMATION 2
- 1. NAV INFORMATION 1
  - 2. WPT (OFF, ON)
  - 4. WPT LINE (OFF, ON)
  - 5. WPT NO. (OFF, ON)
  - 8. ARRIVAL ALARM (OFF, ON)

### NAV INFORMATION 2

- 1. NAV INFORMATION 1
- 2. WIND GRAPH (OFF, ON)
- 3. WIND UNIT (M, S, KT)
- 4. CURRENT DATA (OFF, ON)
- 5. CURRENT GRAPH (OFF, ON)
- 6. DEPTH DATA (OFF, ON)
- 7. DEPTH GRAPH (OFF, ON)
- 8. DEPTH SCALE (10, 20, 50, 100, 200, 500)
- 9. DEPTH UNIT (M, FT, FA)
- 0. NAV INFORMATION 3

- 1. NAV INFORMATION 1
- 2. NAV LINE (OFF, ON)
- 4. NAV WIDTH (OFF, ON)
- 5. WPT NO. (OFF, ON)
- 9. TURNING LINE (OFF, ON, REVISED)

### NAV INFORMATION 3

- 1. NAV INFORMATION 2
- 2. WATER TEMP (OF, ON)
- 3. DATE (OFF, UTC, LOCAL)



# INITIAL SETTING MENU

## INITIAL SETTING 1

- 1. FUNCTIONS 2
  - 2. HD ALIGN
  - 3. TIMING ADJ
  - 4. ANT HEIGHT (6, 8, 10, 15, 20, 25, 35M, MORE)
  - 5. LOG PULSE (200P, NM)
  - 6. OWN SHIP INFORMATION
  - 7. UNIT (NM, SM, KM)\*
  - 8. ON TIME
  - 9. TX TIME
  - 0. INITIAL SETTING 2
- 1. INITIAL SETTING 1
  - 2. SHIP'S LENGTH
  - 3. SHIP'S WIDTH
  - 4. RADAR POSN
  - 6. TURN RATE
  - 7. SPEED RATE

## INITIAL SETTING 2

- 1. INITIAL SETTING 1
- 2. LOG GYRO INPUT (LOG, GYRO)
- 3. TYPE (R, N, G, D)
- 4. KEY BEEP (OFF, ON)\*
- 5. SCANNER STOPPED (ST-BY, TX)
- 6. VIDEO SIGNAL (ANLG, DGTL)
- 7. ALARM LEVEL (4, 5, 6, 7)
- 8. DISPLAY (MAIN, SUB)
- 9. SECTOR BLKG (OFF, ON)
- 0. INITIAL SETTING 3

## INITIAL SETTING 3

- 1. INITIAL SETTING 2
- 2. TRAIL RESTART (OFF, ON)
- 3. ECHO AVG W/O GYRO (OFF, ON)
- 4. HEAD UP TB SCALE (OFF, ON)
- 5. CTR ECHO STRETCH (ST-BY, TX)
- 6. VIDEO CONTRAST (1, 2, 3, 4)
- 7. MAXIMUM RANGE (72, 96, 120)\*
- 8. ECHO FULL COLOR (OFF, ON)\*
- 9. INDEX LINES (S, 3, 6)
- 0. INITIAL SETTING 4

## INITIAL SETTING 4

- 1. INITIAL SETTING 3
- 2. MODEL (FR-2815/2825, OTHER X-BAND, S-BAND)
- 4. SHIPS TYPE (DEEP SEA, OTHERS)
- 5. RJ-7 (OFF, ON)
- 6. RJ-8 (OFF, ON)
- 9. CABLE L. (500, 5000M)
- 0. FACTORY DEFAULT

# FURUNO

## MECHANICAL PARTS LIST

1996- 2

MODEL	FR/FAR-2805 SERIES	PAGE M-1
UNIT	DISPLAY UNIT RDP-115	
REF. DWG	C3418-E01-	

SYMBOL	PARTS NAME	TYPE/DWG. NO	CODE NO.	REMARKS
1	HOOD	03-133-1901-2	100-233-442	
2	FILTER	03-133-1231-2	100-232-842	
3	CARD COVER (1)	03-126-1241-0	100-220-620	
4	GASKET	86-003-1105-2	100-214-752	
5	MONITOR PANEL	03-133-1201-3	100-232-753	
	NAME PLATE (PANEL)	03-133-1209-0	100-232-830	
6	PANEL FIXING PLATE (3)	03-133-1204-2	100-232-782	
7	PANEL FIXING PLATE (1)	03-133-1202-1	100-232-761	
8	MEMORY CARD FIXING PLATE	03-133-1146-1	100-232-741	
9	LEFT COVER	03-133-1302-2	100-232-882	
	LEFT COVER (P)	03-133-1912-1	100-233-461	
10	RIGHT SIDE PLATE	03-133-1101-3	100-232-373	
	LEFT SIDE PLATE	03-133-1102-2	100-232-382	
	REAR PLATE	03-133-1103-2	100-232-392	
	BOTTOM PLATE	03-133-1104-2	100-232-402	
	CRT FIXING PLATE (1)	03-133-1105-1	100-232-411	
	CRT FIXING PLATE (2)	03-133-1106-2	100-232-422	
	SUPPORT PLATE	03-133-1107-2	100-232-432	
	CRT SUPPORT PLATE	03-133-1108-1	100-232-441	
	SOCKET CLAMP PLATE	03-133-1109-1	100-232-451	
	CRT SUPPORT PLATE	03-133-1111-1	100-232-461	
	HANDLE FIXING PLATE	03-133-1134-1	100-232-581	
	FIXING ANGLE (2)	03-133-1135-1	100-232-591	
	CLAMP FIXING PLATE	03-133-1151-0	100-232-690	
	FIXING ANGLE (2)	03-133-1136-1	100-232-601	
	DUCT PLATE	03-133-1152-1	100-233-551	
11	COVER SPONGE (1)	03-133-1153-0	100-232-700	
12	COVER SPONGE (2)	03-133-1154-0	100-232-710	
13	SPACER	SQ-25	000-801-870	
14	PDM PCB PROTECTIVE COVER	03-106-1143-1	100-159-841	
16	TOP COVER	03-133-1303-2	100-232-892	
	TOP COVER (P)	03-133-1913-1	100-233-471	
17	PCB CHASSIS (1)	03-133-1121-2	100-232-472	
	PCB CHASSIS (2)	03-133-1122-2	100-232-482	
	PCB CHASSIS (3)	03-133-1123-1	100-232-491	
19	STAY	03-133-1148-1	100-232-671	
20	PCB SUPPORT PLATE	03-133-1124-2	100-232-502	
	PCB SUPPORT RUBBER	03-133-1125-0	100-232-510	
21	PCB FIXING PLATE	03-133-1127-2	100-232-532	
23	REAR COVER	03-133-1306-1	100-232-921	
	REAR COVER (P)	03-133-1916-0	100-233-510	
25	CLAMP PLATE	03-001-1116-0	300-111-160	
26	COVER CONTACT PLATE	03-133-1133-1	100-232-571	
27	CABLE CLAMP	03-001-1115-1	300-111-151	
28	CLAMP FIXING PLATE	03-133-1145-2	100-232-732	
29	DUCT (2)	03-133-1143-1	100-232-661	
30	DUCT (1)	03-133-1142-2	100-232-652	
31	POWER FIXING PLATE	03-133-1126-1	100-232-521	
32	FAN FIXING PLATE (1)	03-133-1129-1	100-232-551	
33	SPACER	HSA-3015	000-803-015	
34	POWER FIXING PLATE	03-123-1371-3	100-204-273	
35	SHIELD COVER	03-123-1372-2	100-204-282	
36	PCB FIXING DUCT	03-133-1141-2	100-232-642	
37	RIGHT SIDE COVER	03-133-1301-2	100-232-872	
	RIGHT SIDE COVER (P)	03-133-1911-1	100-233-451	
38	FILTER FIXING PLATE	03-133-1149-2	100-232-682	
39	FUSE FIXING PLATE	03-133-1128-1	100-232-541	
40	FAN FIXING PLATE (2)	03-133-1131-1	100-232-561	
41	MOUNTING BASE (1)	03-133-1401-3	100-232-933	
42	COVER FIXING PLATE	03-133-1138-1	100-232-621	
43	FRONT COVER (1)	03-133-1304-2	100-232-902	
	FRONT COVER-1 (P)	03-133-1914-1	100-233-501	
	FRONT COVER (2)	03-133-1305-1	100-232-911	
	FRONT COVER-2 (P)	03-133-1915-0	100-233-480	
44	MOUNTING BASE (2)	03-133-1402-2	100-232-942	
45	PANEL FIXING PLATE (2)	03-133-1203-2	100-232-772	
46	POWER SW SHEET (J)	03-133-1211-0	100-232-850	

SYMBOL	PARTS NAME	TYPE/DWG. NO	CODE NO.	REMARKS
47	POWER SW SHEET (E)	03-133-1221-0	100-232-860	
48	PANEL FIXING PLATE (4)	03-133-1208-0	100-232-820	
			100-232-920	

# FURUNO

## MECHANICAL PARTS LIST

1996- 8

MODEL	FR/FAR-2805	
UNIT	CONTROL UNIT	PAGE
REF. DWG	C3404-E01-A	M-3

SYMBOL	PARTS NAME	TYPE/DWG. NO	CODE NO.	REMARKS
1	BOTTOM PLATE	03-133-1922-1	100-238-271	
2	CABLE COVER	03-133-1604-1	100-233-031	
3	RETAINER	03-133-1613-4	100-235-914	
4	CLAMP PLATE	03-133-1615-0	100-235-930	
5	TRACKBALL COVER	10-044-3104-0	100-111-920	
6	TRACKBALL	EUA-FTF814B	000-115-533	
7	SPACER	4X3 SPCC	000-877-016	
8	KNOB (SMALL)	03-133-1661-0	100-239-920	
9	SLIDE PLATE (L)	03-133-1669-0	100-242-340	
10	SPONGE (2)	03-133-1607-1	100-233-061	
11	INSULATING PLATE	03-133-1617-0	100-235-950	
12	KEY ADAPTOR	03-044-1418	100-155-460	
13	KEYTOP	03-024-9109-1	100-074-171	
14	GASKET FIXING PLATE	03-133-1616-0	100-235-940	
15	SPONGE (1)	03-133-1606-0	100-233-050	
16	DIAL	03-133-1608-4	100-233-074	
17	SPACER	03-032-9112-1	100-104-741	
18	PANEL FIXING MATERIAL	03-133-1605-1	100-233-041	
19	CENTER CHASSIS	03-133-1601-2	100-233-002	
20	SPACER	HSA-3015	000-803-015	
21	LEFT CHASSIS	03-133-1602-3	100-233-013	
22	SIDE PANEL (1)	03-133-1609-1	100-233-081	
23	LEFT SW FILM (E)	03-133-1626-3	100-233-163	
	LEFT SW FILM (J)	03-133-1623-3	100-233-133	
24	GUIDING PLATE	03-133-1618-3	100-235-963	
25	SW FILM1 (E)	03-133-1682-2	100-233-362	
	SW FILM1 (J)	03-133-1681-2	100-233-352	
26	CONTROL UNIT PANEL	03-133-1671-5	100-233-275	
28	LID (1) ASSEMBLY	03-133-1672-4	100-233-284	
29	CONTROL UNIT MOUNTING PLATE	03-133-1921-1	100-233-491	
30	CR SPONGE	03-133-1683-0	100-244-510	
31	LID (2) ASSEMBLY	03-133-1673-4	100-233-294	
32	RP BLIND FILM	03-133-1636-0	100-244-490	
33	RP FLIM (E)	03-133-1635-0	100-244-480	
	RP FILM (J)	03-133-1634-0	100-244-470	
34	COVER	03-133-1665-0	100-239-940	
35	SLIDE PLATE (1)	03-133-1666-0	100-239-950	
36	SLIDE PLATE (2)	03-133-1667-0	100-239-960	
37	RIGHT SW FILM1 (J)	03-133-1622-4	100-233-124	
38	GUID PLATE (R)	03-133-1663-1	100-239-931	
39	RIGHT CHASSIS (2)	03-133-1631-3	100-233-183	
40	SIDE PANEL (2)	03-133-1611-1	100-233-091	
41	NYLON PUSH RIVET	FNRP3X4.5	000-865-858	
42	PROTECTIVE COVER (E)	03-133-1627-2	100-233-172	
42	PROTECTIVE COVER (J)	03-133-1624-2	100-233-142	
43	PM SEAL	03-133-1612-1	100-233-101	
44	KNOB (S)	05-036-0104-0	100-101-850	
47	SLIDE PLATE (R)	03-133-1668-0	100-242-330	
48	BOTTOM PLATE	03-133-1603-5	100-233-025	

# FURUNO

## 機械部品表

### MECHANICAL PARTS LIST

98年 7月

Model	FR-2115/2125	RSB-0074/0075
Unit	空中線部 SCANNER UNIT	Page M-4
Ref. Dwg.	C3464-E04-	

SYMBOL 記号	NAME 部品名	NAME	TYPE 型名	CODE No. コード番号	REMARKS 備考
A101	輻射部組立品	RADIATOR ASSY.	XN20AF	008-485-260	
	輻射部組立品	RADIATOR ASSY.	XN24AF	100-485-270	
A110	リードスイッチ調整板	REED SWITCH MOUNT	RSK-2108	361-121-081	
A114	モーター取付台	MOTOR FIXING PLATE	03-001-3231	300-132-317	
A115	スキャナーカバー	SCANNER COVER	03-001-3261	300-132-613	
A117	パッキン押さえ	CABLE CLAMPING FLANGE	03-001-3213	300-132-131	
A118	ガスケット	PACKING	JISF8801 25C	000-864-901	
A119	ガスケット	PACKING	JISF8801 25C	000-804-901	
A120	ロッカーチェーン	CHAIN	ST-16	000-841-394	
A123	アンテナ取付台	ANTENNA FIXING PLATE	03-144-3201	100-264-100	
A126	VリングA	V-RING	VR-120A	000-850-738	
A127	スキャナー本体	SCANNER HOUSING	03-001-3212	300-132-123	
A128	スキャナーカバー	SCANNER COVER	03-001-3261	300-132-613	
A129	変更キー	KEY	7X7X23	000-866-851	
A130	マグネット	MAGNET	RP-1757 MS4X9X15	000-499-055	
A131	締め付け台	TURNING GEAR FLANGE	RSI-2002	360-920-021	
A132	カンザ (1)	GUIDE RAIL SHIM (1)	RSK-2402	361-124-021	2 pcs.
A133	カンザ (1)	GUIDE RAIL SHIM (2)	RSK-2403	361-124-031	2 pcs.
A134	スライドレール	SLIDE RAIL	RSK-2401	361-124-011	2 pcs.
A135	回転結合器	ROTARY JOINT	RSB-0074/0075	008-487-200	
A136	シールリング	SEAL RING	03-001-3222	300-132-221	
A301	RFモジュール	RF MODULE	RTR-062	008-487-160	
	RFモジュール	RF MODULE	RTR-063	008-487-170	
BG101	ベアリング	BEARING	6013ZZ	000-802-338	
BG102	ベアリング	BEARING	6013ZZ	000-802-338	
G101	駆動ギヤ	DRIVE GEAR	03-001-3232	300-132-334	
G102	従動ギヤ	SCANNER TURNING GEAR	03-001-3243	300-132-412	
GK106	カバー用パッキン	GASKET	03-001-3263	300-132-631	
GK107	グラウンド用ガスケット	GASKET	JISF8801 25C	000-804-901	
GK108	カバー用パッキン	COVER GASKET	03-001-3263	300-132-631	

# FURUNO

## 機械部品表

MECHANICAL PARTS LIST

98年 7月

Model	FR-2115/2125	RTR-062A/063
Unit	RFモジュール RF MODULE	Page M-5
Ref. Dwg.	C3464-E05-	

SYMBOL 記号	NAME 部品名	NAME	TYPE 型名	CODE No. コード番号	REMARKS 備考
1	シールドカバー	SHIELD COVER	03-144-5109	100-266-810	
2	警告ハマーク	WARNNING LABEL	14-055-4202	100-245-220	
3	コンベックス	CABLE TIE	CV-70	000-570324	
4	BN-NHコネクタ	BH-NH CONNECTOR	03-1900 (ファン-3P)	008-486-880	
5	FET押さえ板	FET FIXING PLATE	03-144-5107	100-264-190	
6	(組) VH-MLコネクタ	VH-ML CONNECTOR ASSY.	03-1903	008-486-910	
7	(組) NHコネクタ	NH CONNECTOR ASSY.	03-1904	008-486-920	
8	クランプ	CLAMP	CKS-07-H	000-570-259	
9	アンプケース	AMP CASE	03-144-5102	100-264-130	
10	ナット材	NUT PLATE	03-126-5324	100-246-470	
11	MICアダプター	MIC ADAPTER	03-006-5301	300-653-012	
12	RFシャーシ	RF CHASSIS	03-144-5101	100-264-120	
13	放熱シート	HEAT SINK SHEET	03-144-5106	100-264-180	
14	MD基板取付板	MD PCB FIXING PLATE	03-144-5105	100-264-170	
15	アンプカバー	AMP COVER	03-144-5103	100-264-140	
16	MICアダプター	MIC ADAPTER	03-126-5321	100-242-310	

# FURUNO

## 機械部品表

### MECHANICAL PARTS LIST

99年 1月

Model	FR-2125W	
Unit	空中線部 RSB-0076/77/78	Page
	SCANNER UNIT	M-5A
Ref. Dwg.	C3466-E01-	

SYMBOL 記号	NAME 部品名	NAME	TYPE 型名	CODE No. コード番号	REMARKS 備考
A101	輻射部組立品	RADIATOR ASSY.	XN-12AF XN-20AF XN-24AF	008-485-250 008-485-260 008-485-270	123cm 200cm 240cm
A105	回転結合器	ROTARY JOINT ASSEMBLY	RSB-0076/77/78	008-487-200	
A107	アンテナ取付台	ANTENNA BRACKET	03-144-3201	100-264-100	
A108	アンテナ取付台組品	ANTENNA BRACKET ASSY.	RSB-0074/0075	008-487-190	
A109	シールリング	SEAL RING	03-001-3222	300-132-221	
A110	カラー	COLOR	03-022-3106	100-113-081	
A111	従動歯車	ANTENNA TURNING GEAR	03-022-3103	100-113-052	
A112	マグネット	MAGNET	RP-1757 MS4X9X-15	000-499-055	
A113	マグネット取付板	MAGNET FIXING PLATE	03-022-3105	100-113-070	
A114	締め付け板	TURNING GEAR FLANGE	RSI-2002	360-920-021	
A115	Vリング	V-RING	VR-120A	000-850-738	
A116	スキャナ本体	SCANNER HOUSING	03-023-3007	100-126-540	
A117	メラ蓋 (2)	BLIND PLATE (2)	03-022-3402	100-113-250	
A118	メラ蓋 (1)	BLIND PLATE (1)	03-022-3401	100-113-240	
A119	センサー保護カバー	SENSOR COVER	03-022-3503	100-133-280	FOR DE-ICE
A120	リードスイッチ取付板	REED SWITCH FIXING PLATE	03-022-3107	100-113-090	
A121	ガイド金具	W.G. GUIDE	03-001-5303	300-153-032	
A122	導波管	WAVEGUIDE	03-023-3002	100-112-981	
A123	WG取付板 (1)	W.G. FIXING PLATE (1)	03-023-3003	100-112-991	
A124	WG取付板 (2)	W.G. FIXING PLATE (2)	03-023-3004	100-113-000	
A125	WG取付板 (3)	W.G. FIXING PLATE (3)	03-023-3005	100-113-010	
A126	Eコナ導波管	E-CORNER WAVEGUIDE	03-023-3001	100-112-970	
A127	ヒータ取付板	HEATER RETAINER	03-022-3502	100-113-270	
A128	ヒータ取付台	HEATER FIXING BASE	03-022-3501	100-113-260	
A129	電線貫通金物	CABLE GLAND	JIS F8801	000-870-050	
A133	SWパッキン	SW PACKING	03-006-3213	300-632-131	
A134	スキャナSW取付金具	SE MOUNTING PLATE	03-006-3215	300-632-150	
A135	スキャナSW蓋	SW COVER	03-006-3216	300-632-160	
A136	ボールチェーン組立	BALL CHAIN	TM-14-B-CR No. 2	000-841-373	
A137	SW蓋パッキン	SWITCH COVER PACKING	03-005-3225	300-532-250	
A138	SWメイン板	SW POSITION PLATE	03-006-3217	300-632-171	
A140	モータ取付板ガイド	MOTOR FIXING PLATE GUIDE	03-001-3291	300-132-910	
A141	座金	WASHER	03-022-3203	100-113-140	
A142	駆動歯車	DRIVING GEAR	03-022-3202	100-113-130	
A143	保護カバー	GEAR COVER	03-022-3204	100-113-150	
A144	SRC取付板	SCR FIXING PLATE	03-022-3504	100-113-291	
A145	保護カバー	SCR COVER	03-022-3505	100-120-870	
A146	基板取付板	PC BOARD FIXING PLATE	03-022-3301	100-113-221	
A147	貼りマーク STB-3	LABEL (STB3)	03-022-3211	100-113-210	

SYMBOL 記号	NAME 部品名	NAME	TYPE 型名	CODE No. コード番号	REMARKS 備考
A148	貼りマーク STB-2	LABEL (STB2)	03-022-3209	100-113-200	
A149	コンデンサ取付板	CAPACITOR FIXING PLATE	03-022-3302	100-113-231	FOR 1P MOT
A150	フォトブランカー	PHOTO BLANKER	03-022-3213	100-120-860	
A151	ボス	BOSS	03-022-3212	100-120-850	
A152	ファン加工品	FAN	03-022-3205	100-113-161	
A153	ファンカバー (1)	FAN COVER (1)	03-022-3207	100-113-183	
A154	ファンカバー (2)	FAN COVER (2)	03-022-3208	100-113-192	
A155	スキャナーカバー	SCANNER COVER	03-011-3261	300-132-612	
A156	吊り金具	HOOK	03-001-3264	300-132-640	
A157	ロッカーチェーン	CHAIN	ST-16	000-841-394	
A158	S型止め輪	S-TYPE CIRCLIP	ISTW-8	000-801-454	
A159	ヘリサートコイル	HELECAL INSERT COIL	M8X1.5D	000-867-635	
BG101	ベアリング	BEARING	6013ZZ PS2S	000-802-338	
BT101	カバー用ボルト	HEXAGONAL HEAD BOLT	03-001-3262	300-132-622	
GK103	カバー用パッキン	PACKING	03-001-3263	300-132-631	



# FURUNO

## MECHANICAL PARTS LIST

1995-11

MODEL	FR-2822X/52X/25W/55W	
UNIT	SCANNER UNIT	PAGE
REF. DWG.	C3332-E01-	M-6

SYMBOL	PARTS NAME	TYPE/DWG. NO	CODE NO.	REMARKS
A 100A	SCANNER ASSEMBLY	RSB-0041-N	008-399-340	220V,3P
	SCANNER ASSEMBLY	RSB-0042-N	008-399-360	440V,3P
	SCANNER ASSEMBLY	RSB-0043-N	008-399-380	100V,1P
	SCANNER ASSEMBLY	RSB-0046	008-404-630	200V,1P
A 101A	RADIATOR ASSY. (6.5FT)	XN-3A	008-324-530	200CM
	RADIATOR ASSEMBLY	XN-4A	008-324-130	240CM
	ANTENNA RADIATOR ASSEMBLY	XN5A	008-402-020	300CM
A 102A	FEEDER W.G.ASSEMBLY	XN3A	008-321-280	FOR XN3A
	FEEDER W.G.ASSEMBLY	XN4A	008-321-270	FOR XN4A
A 103	W.G. CLAMP	RSB-2006-1	360-220-061	
A 104	WAVEGUIDE CLAMP INSULATOR	03-003-4003-0	300-340-030	
A 105A	ROTARY JOINT ASSEMBLY	C2P7N2N/8N2N	008-320-520	
A 106	BEARING RETAINER RING	RSI-2001-0	360-920-010	
A 107	ANTENNA BRACKET	03-022-3102-2	100-113-042	
A 108	KEY	03-022-3104-0	100-113-060	
A 109	SEAL RING	03-001-3222-1	300-132-221	
A 110	COLLAR	03-022-3106-1	100-113-081	
A 111	ANTENNA TURNING GEAR	03-022-3103-2	100-113-052	
A 112	MAGNET	RP-1757 MS4X9X15	000-499-055	
A 113	MAGNET FIXING PLATE	03-022-3105-0	100-113-070	
A 114	TURNING GEAR FLANGE	RSI-2002-1	360-920-021	
A 115	V-RING	VR-120A	000-850-738	
A 116	SCANNER HOUSING	03-023-3007-0	100-126-540	
A 117	BLIND PLATE	03-022-3402-0	100-113-250	
A 118	BLIND PLATE	03-022-3401-0	100-113-240	
A 119	SENSOR COVER	03-022-3503-0	100-113-280	FOR DE-ICE
A 120	REED SWITCH FIXING PLATE	03-022-3107-0	100-113-090	
A 121	W.G. GUIDE	03-001-5303-2	300-153-032	
A 122	WAVEGUIDE	03-023-3002-1	100-112-981	
A 123	W.G.FIXING PLATE(1)	03-023-3003-1	100-112-991	
A 124	W.G.FIXING PLATE(2)	03-023-3004-0	100-113-000	
A 125	W.G.FIXING PLATE(3)	03-023-3005-0	100-113-010	
A 126	E-CORNER WAVEGUIDE	03-023-3001-0	100-112-970	
A 127	HEATER RETAINER	03-022-3502-0	100-113-270	
A 128	HEATER FIXING BASE	03-022-3501-0	100-113-260	
A 129	CABLE GLAND	JIS F8801 A30B BRASS	000-870-050	
A 133	SW PACKING	03-006-3213-1	300-632-131	
A 134	SW MOUNTING PLATE	03-006-3215-0	300-632-150	
A 135	SW COVER	03-006-3216-0	300-632-160	
A 136	BALL CHAIN	TM-14-B-CR NO.2	000-841-373	
A 137	SWITCH COVER PACKING	03-005-3225-0	300-532-250	
A 138	SW POSITION PLATE	03-006-3217-1	300-632-171	
A 140	MOTOR FIXING PLATE GUIDE	03-001-3291-0	300-132-910	
A 141	WASHER	03-022-3203-0	100-113-140	
A 142	DRIVING GEAR	03-022-3202-0	100-113-130	
A 143	GEAR COVER	03-022-3204-0	100-113-150	
A 144	SCR FIXING PLATE	03-022-3504-1	100-113-291	
A 145	SCR COVER	03-022-3505-0	100-120-870	
A 146	PC BOARD FIXING PLATE	03-022-3301-1	100-113-221	
A 147	LABEL (STB3)	03-022-3211-0	100-113-210	
A 148	LABEL (STB2)	03-022-3209-0	100-113-200	
A 149	CAPACITOR FIXING PLATE	03-022-3302-1	100-113-231	FOR 1P MOT
A 150	PHOTO BLANKER	03-022-3213-0	100-120-860	
A 151	BOSS	03-022-3212-0	100-120-850	
A 152	FAN	03-022-3205-1	100-113-161	
A 153	FAN COVER (1)	03-022-3207-3	100-113-183	
A 154	FAN COVER (2)	03-022-3208-2	100-113-192	
A 155	SCANNER COVER	03-001-3261-2	300-132-612	
A 156	HOOK	03-001-3264-0	300-132-640	
A 157	CHAIN	ST-16	000-841-394	
A 158	S-TYPE CIRCLIP	ISTW-8	000-801-454	
A 159	HELICAL INSERT COIL	M8X1.5D	000-867-635	
BG 101	BEARING	6013ZZ PS2S	000-802-338	
BT 101	HEXAGONAL HEAD BOLT	03-001-3262-2	300-132-622	

UNIT	SCANNER UNIT		REF. DWG.	C3332-E01-	PAGE	M-7
SYMBOL	PARTS	NAME	TYPE/DWG. NO	CODE NO.	REMARKS	
GK 101	O-RING		AS568-125, 1115-70	000-851-840		
GK 102	O-RING		AS568-142, 1115-70	000-851-855		
GK 103	PACKING		03-001-3263-1	300-132-631		

# FURUNO

## MECHANICAL PARTS LIST

1996- 6

MODEL	FR/FAR-2825W	
UNIT	TRANSCEIVER RTR-046	PAGE
REF. DWG.	C3405-E01-	M-8

SYMBOL	PARTS NAME	TYPE/DWG. NO	CODE NO.	REMARKS
A 1	BASE	03-130-5101-1	100-235-571	
A 2	SEAL PLATE	03-130-5105-0	100-235-610	
A 3	CABLE CLAMP	03-010-5108-3	301-051-083	
A 4	CLAMP PLATE	03-010-5109-0	301-051-090	
A 5	SPACER	BSB-311	000-807-400	
A 6	FUSE FIXING PLATE	03-130-5103-0	100-235-590	
A 7	LID (FUSE)	03-130-5107-0	100-235-990	
A 8	RF CASE	03-130-5102-1	100-235-581	
A 9	RF ASSEMBLY			
A 10	BASE	03-130-5101-0	100-235-570	
	FILTER	03-130-5202-0	100-235-710	
A 11	NAME PLATE (TR/RX)	03-800-0651-0	100-060-230	
A 12	PIN	03-010-5104-0	301-051-040	
A 13	PIN FIXING PLATE	03-010-5103-0	301-051-030	
A 14	W.G. ASSY.	03-010-5120-1	301-051-201	
	CONVERSION FLANGE	03-010-5121-1	100-235-631	
	WAVE GUIDE (1)	03-010-5122-0	100-235-640	
	CHOKE FLANGE	FOR WRJ-10	000-879-252	
	WAVEGUIDE	RRI-1102-1	340-911-021	
A 15	WATERPROOFING FILM RF.	03-010-5123-1	100-070-631	
A 16	POWER COVER	03-130-5125-1	100-235-691	
A 17	SPACER (3)	HSA-4070	000-804-070	
A 18	RADIATION PLATE	03-130-5121-2	100-235-652	
	TR CLAMP	03-130-5122-0	100-235-660	
	RUBBER CLAMP	03-130-5123-1	100-235-671	
	RADIATION SHEET	03-130-5124-0	100-235-680	
A 19	SPACER (180)	03-130-5104-0	100-235-600	
A 20	SPACER	BSB-325	000-804-978	
A 21	GASKET	UC-300275 *1M*	000-807-399	

# FURUNO

## MECHANICAL PARTS LIST

1995-11

MODEL	FR-2050X/2852X/2855W	
UNIT	RTR-010 TRANSCEIVER	PAGE
REF. DWG.	C3300-003-	M-9

SYMBOL	PARTS NAME	TYPE/DWG. NO	CODE NO.	REMARKS
A	301	CHASSIS	03-017-5101-2	100-062-072
A	302	COVER	03-017-5201-0	100-062-270
A	303	FAN FIXING PLATE	03-017-5127-0	100-070-550
A	304	BLIND PLATE	03-017-5118-0	100-062-230
A	305	SHIELD CASE FIXING PLATE	03-017-5125-0	100-070-530
A	306	SPONGE	03-017-5128-0	100-070-560
A	307	PT FIXING PLATE	03-017-5112-0	100-062-170
A	308	HEAT SINK	03-017-5113-0	100-062-180
A	309	SHIELD CASE	03-017-5111-2	100-062-162
A	310	STOPPER	03-017-5117-2	100-062-222
A	311	CONNECTOR FIXING PLATE	03-017-5115-0	100-062-200
A	312	CABLE CLAMP (1)	03-017-5109-0	100-062-150
A	313	BOTTOM PLATE	03-017-5603-1	100-062-741
A	314	SIDE PLATE (1)	03-017-5601-1	100-062-721
A	315	SIDE PLATE (2)	03-017-5602-1	100-062-731
A	316	TOP PLATE	03-017-5604-2	100-062-752
A	317	GUIDE PLATE	03-017-5116-0	100-062-210
A	318	METER FIXING PLATE	03-017-5605-1	100-062-761
A	319	FUSE FIXING PLATE	03-017-5107-1	100-062-131
A	320	COVER	03-017-5108-0	100-062-140
A	321	AIR FILTER CASE	03-017-5103-0	100-062-090
A	322	AIR FILTER	03-017-5104-0	100-062-100
A	323	FOOT	03-012-5108-1	301-251-081
A	324	METER FIXING PLATE	03-017-5106-0	100-062-120
A	325	DRAIN WAVEGUIDE (H)	03-017-0360-0	100-062-800
A	326	WAVEGUIDE FLANGE (2)	03-017-5420-4	100-062-554
A	327	LINER	03-017-5423-0	100-070-620
A	328	RETAINING BAR (2)	03-017-5205-0	100-062-310
A	329	EARTHING FIXTURE (H)	03-017-5203-0	100-062-290
A	330	CUSHION (2)	03-017-5207-0	100-062-330
A	331	RETAINING BAR (1)	03-017-5204-0	100-062-300
A	332	EARTHING FIXTURE (V)	03-017-5202-0	100-062-280
A	333	CUSHION (1)	03-017-5206-0	100-062-320
A	334	BOLT	03-017-5208-0	100-062-340
A	335	SEAL WASHER	03-009-3219-0	100-004-550
A	336	SPACER	HSA-3035	000-803-035
A	337	SPACER	SB-6M3-10-BS	000-877-113
A	338	SPACER (2)	HSA-3045	000-803-045
A	339	SPACER	HSA-3015	000-803-015
A	340	SPACER (2)	HSA-3010	000-803-010
A	341	TRANSFORMER FIXING PLATE	03-017-5114-0	100-062-190
A	342	LABEL (R)	03-017-5611-0	100-062-770
A	343	LABEL (F)	03-017-5122-0	100-062-250
A	344	STICKER (HIGH VOLTAGE)	R-12135-D-0	390-100-010
A	345	HOURLY METER WINDOW	03-010-5133-0	301-051-330
A	346	NAME PLATE	03-009-0117-1	300-901-171
A	347	SPACER	HSA-4040	000-804-040
A	348	CLAMP PLATE	03-010-5109-0	301-051-090
A	349	BOLT	03-017-5314-0	100-062-470
A	350	NYLON RIVET	FNRP 3X6.5 BLACK	000-865-859
A	351	LABEL (A)	03-017-5612	100-062-260
A	352	LABEL (T)	03-017-5121-1	100-062-241
A	400A	TX MODULE	RTR-010	008-234-240
A	401	SIDE PLATE (1)	03-017-5301-4	100-062-354
A	402	BOTTOM PLATE	03-017-5303-1	100-062-371
A	403	TOP PLATE	03-017-5304-0	100-062-380
A	404	SIDE PLATE (2)	03-017-5302-3	100-062-363
A	405	FAN GUIDE	03-017-5305-2	100-062-392
A	406	SCR FIXING BASE	03-017-5311-1	100-062-441
A	407	SCR FIXING PLATE	03-017-5312-0	100-062-450
A	408	HINGE (1)	03-009-1004-1	300-910-041
A	409	HINGE FIXING PLATE	03-017-5126-1	100-070-541
A	410	STOPPER	03-017-5316-0	100-062-490
A	411	BOBBIN FIXTURE	03-017-5313-0	100-062-460

UNIT	RTR-010 TRANSCEIVER		REF. DWG.	C3300-003-	PAGE	M-10
SYMBOL	PARTS	NAME	TYPE/DWG. NO	CODE NO.	REMARKS	
A	412	MAGNETRON FIXING PLATE	03-017-5309-0	100-062-430		
A	413	FAN GUARD	109-019C	000-102-963		
A	414	SWITCH FIXING PLATE	03-017-5317-0	100-062-500		
A	415	BOBBIN	03-017-5315-0	100-062-480		
A	416	HEAT SINK	GE-50	000-108-677		
A	417	SPACER	03-009-1006-0	300-910-060		
A	418	IF AMP CASE LID	03-017-5505-0	100-062-710		
A	419	IF AMP CASE	03-017-5504-0	100-062-700		
A	420	IF AMP CASE FIXING PLATE	03-007-5314-0	100-049-110		
A	421	MAGNETRON FLANGE	03-017-5413-0	100-062-540		
A	422	WAVEGUIDE FLANGE (1)	03-017-5410-1	100-062-511		
A	423	CIRCULATOR FIXING PLATE	03-017-5306-4	100-062-404		
A	424	REINFORCEMENT PLATE (2)	03-017-5308-0	100-062-420		
A	425	REINFORCEMENT PLATE (1)	03-017-5307-1	100-062-411		
A	426	WAVEGUIDE ADAPTOR (2)	03-017-5443-0	100-062-640		
A	427	WAVEGUIDE FLANGE (3)	03-017-5430-3	100-062-583		
A		WAVEGUIDE FLANGE (4)	03-017-5440-0	100-062-613		
A	428	WAVEGUIDE PLAIN FLANGE	03-017-5502-0	100-062-680		
A	429	SHIELD CASE	03-017-5501-0	100-062-670		
A	430	MIC ADAPTOR	03-017-5503-0	100-062-690		
A	431	FILTER WAVEGUIDE	03-011-5342-0	100-062-650		
A	432	FILTER	03-011-5343-1	100-062-661		
A	433	LABEL	03-017-5131-0	100-070-610		
A	434	LABEL	03-017-5129-0	100-070-600		
A	435	STICKER (HIGH VOLTAGE)	R-12135-D-0	390-100-010		
A	436	LABEL 6	03-004-0206-2	300-402-062		
A	437	SPACER	HSA-4095	000-804-095		
A	438	SPACER	SB8M4-15-BS	000-877-111		
A	439	SPACER (2)	HSA-3010	000-803-010		
A	440	SPACER (3)	HSA-4015	000-804-015		
A	441	GROMMET	NG-79-0 30X25X20X8	000-871-215		
A	442	GROMMET	NG-79-K	000-871-211		

# FURUNO

## 機械部品表

### MECHANICAL PARTS LIST

2001年 8月

Model	FR-2135S/FR-2835S	
Unit	空中線ユニット	Page M-11
Ref.Dwg.	C3469-E01-A	

SYMBOL 記号	NAME 部品名	NAME	TYPE 型名	CODE No. コード番号	REMARKS 備考
A100A	空中線筐体	SCANNER HOUSING	RSB-0026-066-N	008-493-470	
			RSB-0026-066-I	008-493-480	
			RSB-0026-066-N-HK	008-493-490	
			RSB-0026-066-I-HK	008-493-500	
			RSB-0031-066-N	008-493-510	
			RSB-0031-066-I	008-493-520	
			RSB-0031-066-N-HK	008-493-530	
			RSB-0088-066-N	008-525-300	
			RSB-0088-066-I	008-525-400	
			RSB-0089-066-N	008-525-050	
			RSB-0089-066-I	008-525-060	
			RSB-0090-066-N	008-525-070	
			RSB-0089-066-I	008-525-080	
A101A	アンテナ部組品	ANTENNA RADIATOR ASSY.	SN5AF	008-243-630	
	アンテナ部組品	ANTENNA RADIATOR ASSY.	SN7AF	008-243-650	
A103	アンテナ取付台	ANTENNA BRACKET	03-015-3213	100-090-540	
A105A	ロータリジョイント組品	ROTARY JOINT ASSY.	RSB-0026/27/31	008-243-590	
A106	ヘリサート	HELI-SERT	M10-1.5X1DNS	000-801-591	
A107	チョークガイド	CHOKE GUIDE	03-015-3235	100-090-740	
A108	深溝玉軸受け	BALL BEARING	6809VV	000-801-590	
A109	Oリング	O-RING	JISB2401-1A-G65	000-851-310	
A110	開口面貼りマーク	LABEL	03-029-0202	100-091-100	
A111	メインシャフト	MAIN SHAFT	03-015-3214	100-090-550	
A112	シールリング	SEAL RING	03-015-3215	100-090-560	
A113	キー	KEY	03-015-3216	100-090-570	
A114	Vリング	V-RING	VR-130A	000-850-739	
A115	ベアリング固定金具	BEARING FIXING PLATE	03-011-3218	100-049-531	
A116	ベアリング	BEARING	6014ZZ	000-873-273	
A117	スペーサ(1)	SPACER (1)	03-015-3217	100-090-580	
A118	舷側部筐体	GEAR BOX	03-015-3212	100-090-530	
A119	メクラ蓋 .1.	BLIND PLATE	03-006-3293	300-632-920	
A120	上部パッキン	HEATER BRACKET	03-006-3293	300-632-930	
A121	従道歯車	SCANNER TURNING GEAR	03-015-3226	100-090-660	
A122	スペーサ(2)	SPACER (2)	03-015-3218	100-090-590	
A123	ベアリング	BEARING	6014ZZ	000-873-273	
A124	ブラケット	BRACKET	03-015-3219	100-090-600	
A125	信号歯車(1)	TIMING GEAR	03-015-3223	100-090-630	
A126	ベアリング用ワッシャ	BEARING WASHER	AW-13X	000-809-969	
A127	ベアリング用ナット	BEARING NUT	AN-13	000-800-968	
A128	マグネット取付板	MAGNET FIXING PLATE	03-015-3225	100-090-650	
A129	スペーサー	SPACER	SB8M4-10-BS	000-655-988	
A130	メクラ蓋 .1.	BLIND PLATE	03-011-3224	100-049-580	
A131A	ヒータ取付台	HEATER MOUNTING BASE	03-011-3501	100-049-940	FOR DE-ICER
	ヒーター押さえ板	HEATER SUPPORTING PLATE	03-006-3282	300-632-820	FOR DE-ICER
	リード線引出し口	HEATER LEAD WIRE OUTLET	03-006-3283	300-632-830	FOR DE-ICER
A132	センサーカバー	SENSOR COVER	03-006-3219	300-632-190	FOR DE-ICER
A133	センサーパッキン	SENSOR BRACKET	RSR-2112	361-821-120	

SYMBOL 記号	NAME 部品名	NAME	TYPE 型名	CODE No. コード番号	REMARKS 備考
A134	周り止め	KEY	03-015-3224	100-090-640	
A135	基板取付板	PC BOARD FIXING PLATE	03-015-3222	100-090-620	
A137	サーマルSW取付アング	THERMAL SWITCH FIXING PLATE	RSR-2114	361-821-140	
A139A	変換器	WAVEGUIDE ADAPTOR	03-01-3301	100-049-680	
	外動体	CONDUCTOR	03-015-3301	100-090-760	
A140	芯出し金具	CENTERING MATAL	03-011-3225	100-049-591	
A141	スキャナー本体	SCANNER CHASSIS	03-015-3201	100-090-480	
A160	モーターカバー	MOTOR COVER	03-015-3101	100-090-450	
A161	モーターパッキン	MOTOR COVER GASKET	03-015-3102	100-090-460	
A162A	スキャナーSW蓋	SW COVER	03-006-3216	300-632-160	
	SW蓋パッキン	SWITCH COVER GASKET	03-005-3225	300-532-250	
	ボールチェーン組立	SWITCH COVER CHAIN	TM-14-B-CR NO.2	000-841-376	
A163	SWメインバン	SW POSITION PLATE	03-006-3217	300-632-171	
A164	スキャナーSW取付金具	SW MOUNTING PLATE	03-006-3215	300-632-150	
A165	SWパッキン	SW PACKING	03-006-3213	300-632-131	
A166	電線貫通金物	CABLE GLAND	JIS F8801 A30B	000-870-050	
A167	貫通金物ナット無し	CABLE GLAND	JISF8801 A25C	000-870-151	
A168	アース棒	EARTH BOLT	03-011-3226	100-049-601	
A169	取付ボルト	COVER FIXTURE BOLT	03-015-3103	100-090-470	
A170	ゴムワッシャ	RUBBER WASHER	03-011-3105	100-049-360	
A171	テフロン座金	TEFLON WASHER	03-011-3106	100-057-100	
A172	座金	WASHER	03-011-3104	100-049-350	
A173	カバー	COVER	03-011-3101	100-049-320	
A174	パッキン	COVER GASKET	03-011-3102	100-049-330	
A175	ボルト	COVER FIXING BOLT	03-011-3103	100-049-340	
A177	サーキュラタ用ボルト	CIRCULATOR FIXING BOLT	03-015-3204	100-090-510	
A178	取付アングル	FIXING ANGLE	03-015-3211	100-090-520	
A179	吊り上げ金具	LIFTING FIXTURE	03-015-3241	100-095-230	
A180	ピン	PIN	03-011-3206	100-049-421	
A181	RTB貼りマーク	LABEL	03-029-0201	100-091-090	
A182	ヘリサートコイル	HELICAL INSERT COIL	M8X105D	000-867-635	
A183	固定金具	DRIVE GEAR RETAINER	03-015-3225	100-090-680	
A184	駆動歯車	DRIVE GEAR	03-015-3227	100-090-670	
A185	モーター取付板	MOTOR FIXING PLATE	03-015-3229	100-090-690	
A186	位置決めボルト	POSITIONING BOLT	03-015-3231	100-090-700	
A187	放熱板	HEAT SINK	03-016-5105	100-050-000	
A188	アダプタ取付板	ADAPTER FIXING PLATE	03-012-3202	100-062-970	
A189	アダプタ	ADAPTER FOR MUGNETROI	03-012-3201	100-062-961	
A190	ファンカバー	FAN MOTOR COVER	03-012-3204	100-062-990	
A191	ファン取付スペーサー	SPACER FOR FAN MOTOR	03-012-3203	100-062-980	
A192	クレモナロープ	ROPE	4 $\phi$ イ *600MM*	000-835-320	
A193	カップリング	COUPLING	STB-01 SUS	000-844-165	
A194	ピン	PIN	03-015-3232	100-090-710	
A195	メクラ蓋	BLIND PLATE	03-015-3202	100-090-490	
A196	エンコーダ取付板	ENCODER FIXING PLATE	03-015-3221	100-090-610	
A197	マグネット	MAGNET	RP-1757 MS4X9X1	000-499-055	
A200A	アンテナ取付台	ANTENNA BRACKET ASSY.	RSB-0026	008-256-310	
A302	RFカバー	TRANSMITTER COVER	03-018-5102	100-063-010	
A306	スペーサ	SPACER	03-018-5106	100-063-050	
A311	貼りマーク	STICKER (HIGH VOLTAGE)	R-12135-D-0	390-100-010	
A312	注意貼りマーク	LABEL "CAUTION"	03-025-0202	100-063-071	
A313A	TRシャーシ組品	TX CHASSIS ASSY.	TX CHASSIS ASSY	008-493-020	

SYMBOL 記号	NAME 部品名	NAME	TYPE 型名	CODE No. コード番号	REMARKS 備考
A400	端子台取付板(1)	TERMINAL BOARD PLATE (103-145-3101		100-265-310	
A401	スペーサ	SPACER	05-003-0035	590-300-350	
A402	端子台取付板(2)	TERMINAL BOARD PLATE (203-145-3102		100-265-320	
A403	保護カバー	COVER	03-144-3202	100-264-110	
A404	スペーサ	SPACER	SQ-6	000-801-699	
A405	サーキュレータ取付板	CIRCULATOR FIXING PLATE	03-015-3203	100-090-050	
A406	サーキュレータ固定金具	CICUIT FIXING ANGLE	03-011-3227	100-049-611	
A407	アンプケース蓋	AMP. CASE COVER	03-145-5103	100-265-400	
A408	MIC注意貼りマーク	MIC LABEL	03-145-5106	100-265-940	
A409	アンプケース	AMP. CASE	03-145-5102	100-265-390	
A410	シールドカバー	SHIELD COVER	03-145-5104	100-265-410	
A411	アンプ/MIC取付板	AMP./MIC FIXING PLATE	03-145-5101	100-265-381	
A412	MIC押さえ板	MIC SUPPORTER	03-145-5105	100-265-420	
A413A	アンプ/MIC組品	AMP./MIC ASSY.	RSB-0026/31-066	008-491-530	
A414	MD基板取付板	MO BOARD PLATE	03-145-5002	100-265-340	
A415	FET押さえ板	FET SUPPORTER	03-145-5003	100-265-350	
A416	放熱シート	HEAT SHEET	03-144-5106	100-264-180	
A417	RFシャーシ	RF CHASSIS	03-145-5001	100-265-330	
A418	貼りマーク	LABEL	03-017-0207	100-056-580	



# FURUNO

## 機械部品表

### MECHANICAL PARTS LIST

2000年 6月

Model	FR-2835SW-30AF/36AF	
Unit	空中線部 RSB-0027/0032	Page
	SCANNER UNIT	M-14A
Ref.Dwg.	C3470-E01-A	

SYMBOL 記号	NAME 部品名	NAME	TYPE 型名	CODE No. コード番号	REMARKS 備考
A101A	アンテナ部組品	ANTENNA RADIATOR ASSY.	SN30AF	008-505-920	
	アンテナ部組品	ANTENNA RADIATOR ASSY.	SN36AF	008-505-910	
A103	アンテナ取付台	ANTENNA BRACKET	03-015-3213	100-090-540	
A104	ブラインドカバー	PROTECTION CAP	03-029-0402	100-091-131	
A106	チョークガイド	CHOKE GUIDE	03-015-3235	100-090-740	
A107	深溝玉軸受け	BALL BEARING	6809VV	000-801-590	
A108	リング	O-RING	JISB2401-1A-G65	000-851-310	
A109	開口面貼りマーク	LABEL	03-029-0202	100-091-100	
A110	メインシャフト	MAIN SHAFT	03-015-3214	100-090-552	
A111	シーリング	SEAL RING	03-015-3215	100-090-560	
A112	キー	KEY	03-015-3216	100-090-570	
A113	Vリング	V-RING	VR-130A	000-850-739	
A114	ベアリング固定金具	BEARING FIXING PLATE	03-011-3218	100-049-531	
A115	マグネット取付板	MAGNET FIXING PLATE	03-015-3225	100-090-650	
A118	ブラインドカバー	PROTECTION CAP	03-006-3292	300-632-920	
A119	上部パッキン	HEATER PACKING PLATE	03-006-3293	300-632-930	
A120A	ヒータ取付台	HEATER MOUNTING PLATE	03-011-3501	100-049-940	FOR DE-ICER
	ヒータ押さえ板	HEATER SUPPORTING PLATE	03-006-3282	300-632-820	FOR DE-ICER
	リード線引出し口	HEATER LEAD WIRE OUT	03-006-3283	300-632-830	FOR DE-ICER
A121	ベアリング	BEARING	6014ZZ	000-873-273	
A122	スペーサ(1)	SPACER(1)	03-015-3217	100-090-580	
A123	舷側部筐体	GEAR BOX	03-015-3212	100-090-532	
A124	従動歯車	SCANNER TURNING GEAR	03-015-3226	100-090-660	
A125	スペーサ(2)	SPACER (2)	03-015-3218	100-090-590	
A126	ベアリング	BEARING	6014ZZ	000-873-273	
A127	ブラケット	BRACKET	03-015-3219	100-090-601	
A128	信号歯車(1)	TIMING GEAR	03-015-3223	100-090-630	
A129	ベアリング用ワッシャー	BEARING WASHER	AW-13X	000-800-969	
A130	ベアリング用ナット	BEARING NUT	AN-13	000-800-968	
A131	エンコーダ取付板	ENCODER FIXING PLATE	03-015-3221	100-090-611	
A132	スペーサ	SPACER	SB8M4-10-BS	000-655-988	
A133	ブラインドカバー	PROTECTION CAP	03-011-3224	100-049-580	
A134	センサーカバー	SENSOR COVER	03-006-3219	300-632-190	FOR DE-ICER
A135	センサーパッキン	SENSOR PACKING	RSR-2112	361-821-120	
A136	基板取付板	PC BOARD FIXING PLATE	03-015-3222	100-090-620	
A137	アダプタ	ADAPTOR	03-012-5402	301-254-020	
A138A	変換器	WAVEGUIDE ADAPTOR	03-011-3301	100-049-680	
	外動体	CONDUCTOR	03-015-3301	100-090-760	
A139	芯出し金具	CENTERING METAL	03-011-3225	100-049-591	
A140	スキャナ本体	SCANNER CHASSIS	03-016-3201	100-091-163	
A141	カバー	COVER	03-011-3101	100-049-320	

SYMBOL 記号	NAME 部品名	NAME	TYPE 型名	CODE No. コード番号	REMARKS 備考
A142	パッキン	COVER PACKING	03-011-3102	100-049-330	
A144	WG固定金具	WAVEGUIDE RETAINER	03-016-3205	100-091-200	
A145	導波管	WAVEGUIDE	03-016-3202	100-091-170	
A146	Oリング	O-RING	ARP568-345	000-851-891	
A147A	スキャナースW蓋	SW COVER	03-006-3216	300-632-160	
	SW蓋パッキン	SWITCH COVER PACKING	03-005-3225	300-532-250	
	ホルチェン組立	SWITCH COVER CHAIN	TM-14-B-CR	000-841-376	
A148	スキャナースW取付金具	SW MOUNTING PLATE	03-006-3215	300-632-150	
A149	SWパッキン	SW PACKING	03-006-3213	300-632-131	
A150	モーターカバー	MOTOR COVER	03-015-3101	100-090-454	
A151	モーターパッキン	MOTOR COVER PACKING	03-015-3102	100-090-460	
A152	アース棒	EARTH BOLT	03-011-3226	100-049-601	
A153	WG取付板	WAVEGUIDE FIXING PLATE	03-016-3204	100-091-190	
A154	サマルSW押さえ板	TERMINAL SW SUPPORT	RSR-2115	361-821-150	
A155	サマルSW取付アングル	TERMINAL SW FIXING PLATE	RSR-2114	361-821-140	
A156	固定金具	DRIVE GEAR RETAINER	03-015-3228	100-090-680	
A157	駆動歯車	DRIVE GEAR	03-015-3227	100-090-671	
A158	モーター取付板	MOTOR FIXING PLATE	03-015-3229	100-090-690	
A159	位置決めボルト	POSITIONING BOLT	03-015-3231	100-090-700	
A160	取付アングル	FIXING ANGLE	03-015-3211	100-090-522	
A161	WG取付ボルト	WAVEGUIDE FIXING BOLT	03-016-3203	100-091-180	
A162	吊り上げ金具	LIFTING FIXTURE	03-015-3241	100-095-230	
A163	ピン	PIN	03-011-3206	100-049-421	
A164	SS基板取付板	PC BOARD FIXING PLATE	03-015-3237	100-094-360	
A165	取付金具	FIXTURE	03-015-3238	100-094-370	
A166	端子台取付板	TERMINAL BOARD PLATE	03-015-3236	100-090-751	
A167	エッジング	EDGING	CE-024 *1M*	000-570-285	
A168	蝶板	HINGE	TH-TM-5	000-872-005	
A169	トライアック取付板	TRIAC FIXING PLATE	03-011-3502	100-049-950	
A170	RTBハリマーク	LABEL	03-029-0201	100-091-090	
A171	ボルト	COVER FIXING BOLT	03-011-3103	100-049-340	
A172	取付ボルト	COVER FIXING BOLT	03-015-3103	100-090-470	
A173	ゴムワッシャ	RUBBER WASHER	03-011-3105	100-049-360	
A174	テフロン座金	TEFLON WASHER	03-011-3106	100-057-100	
A175	座金	WASHER	03-011-3104	100-049-350	
A176	ピン	PIN	03-015-3232	100-090-710	
A177	ヘリサートコイル	HELICAL INSERT COIL	-1.25X1.5DNS	000-867-635	
A178	クモロロープ	ROPE	φ 4 600mm	000-835-320	
A179	カップリング	COUPLING	SBP-50K SUS	000-844-165	
A180	ブラインドカバー	BLIND PLATE	03-030-0401	100-091-640	
A181	ハリマーク (40)	LABEL	RNC-1040	390-310-400	
A182	回り止め	KEY	03-015-3224	100-090-640	
A183	SWメイン板	SW POSITION PLATE	03-006-3217	300-632-172	
A200A	アンテナ取付台	ANTENNA BRACKET ASSY	RSB-0026	008-256-310	

# FURUNO

## MECHANICAL PARTS LIST

1996- 2

MODEL	FR/FAR-2835SW	
UNIT	TRASCEIVER UNIT	PAGE
REF. DWG.	C3405-E01-	M-15

SYMBOL	PARTS NAME	TYPE/DWG. NO	CODE NO.	REMARKS
A 201	COVER	03-030-5101-0	100-134-380	
A 203	AIR FILTER	03-030-5103-0	100-134-400	
A 204	FILTER RETAINER	03-030-5104-0	100-134-410	
A 205	CLASP *HOOK & LOCK*	C-1007-2 00S0053-0	000-872-857	
A 211	MAIN CHASSIS	03-030-5201-4	100-134-424	
A 212	FIXING PLATE	03-030-5202-1	100-134-431	
A 213	MOUNTING ANGLE (L)	03-030-5203-0	100-134-440	
A 214	WG OUTLET ADAPTOR	03-030-5204-1	100-134-451	
A 215	WEEP PROTECTION BLOCK	03-030-5206-0	100-134-470	
A 216	GAP ADJUSTOR	03-030-5205-1	100-134-461	
A 217	RF CHASSIS FIXING ANGLE	03-030-5207-0	100-134-480	
A 218	POSITIONING PIN	03-030-5208-1	100-134-491	
A 219	PLATE	03-030-5209-1	100-134-501	
A 220	DUCT	03-030-5211-2	100-134-512	
A 221	SHIELD COVER	03-030-5212-1	100-134-521	
A 222	METER PANEL FIXING ANGLE	03-030-5213-0	100-134-530	
A 223	METER PANEL	03-030-5214-1	100-134-541	
A 225	BOTTOM PLATE	03-030-5216-0	100-134-560	
A 228	CABLE CLAMP FIXING PLATE	03-030-5219-0	100-134-590	
A 229	CORNER PLATE	03-030-5221-0	100-134-600	
A 231	CABLE CLAMP	03-010-5108-3	301-051-083	
A 232	CLAMP PLATE	03-010-5109-0	301-051-090	
A 234	BLIND PLATE	03-023-5219-0	100-091-410	
A 235	STICKER (HIGH VOLTAGE)	R-12135-D-0	390-100-010	
A 237	HINGE	TH-TM-11	000-872-011	
A 238	FILTER RETAINER	03-023-5218-0	100-091-400	
A 251	BELT DAMPER	E06-10426-1	100-034-631	
A 252	RF SHIELD COVER	03-030-5302-1	100-134-631	
A 253	AIR SHUTTER	03-030-5303-0	100-134-640	
A 254	RF CHASSIS FIXING PLATE	03-030-5304-2	100-134-652	
A 255	SUPPORTING PIN	03-030-5305-0	100-134-660	
A 256	CORNER PLATE	03-030-5306-0	100-134-670	
A 257	NUT	03-030-5307-0	100-134-680	
A 258	CAUTION LABEL	03-030-5308-0	100-137-630	
A 259	BOARD FIXING PLATE	03-130-5601	100-253-760	
A 260	MAGNETRON FIXING ANGLE	03-023-5307-0	100-091-490	
A 261	MAGNETRON FIXING PLATE	03-023-5308-0	100-091-500	
A 263	GROMMET	NG-79-M	000-871-213	
A 264	GROMMET	NG-79-Q	000-871-217	
A 272	CIRCULATOR FIXING ANGLE	03-030-5405-0	100-134-730	
A 273	E-CORNER FIXING PLATE	03-023-5403-0	100-091-560	
A 274	ADAPTOR	03-012-5402-0	301-254-020	
A 275	HY MOUNTING PLATE (2)	03-012-5404-0	301-254-040	
A 276	FILTER WAVEGUIDE	03-018-5301-0	100-098-160	
A 277	FILTER	03-018-5302-0	100-098-170	
A 278	MIC FIXTURE	03-023-5406-0	100-091-590	
A 279	IF AMP CASE FIXING PLATE	03-007-5314-0	100-049-110	
A 280	LABEL	03-017-5506-0	100-070-590	
A 281	IF AMP CASE COVER	03-017-5505-1	100-062-711	
A 282	IF AMP CASE	03-017-5504-0	100-062-700	
A 283	CONNECTOR FIXING PLATE	03-023-5501-0	100-091-620	
A 285	BOARD FIXING PLATE	03-023-5405-0	100-091-580	
A 286	EARTHING PLATE	03-030-5501-1	100-137-641	
A 291	TERMINAL	ST-A8	000-536-358	
A 292	SPACER	SB8M4-10-BS	000-655-988	
A 293	SPACER	HSA-4065	000-804-065	
A 295	SPACER *B*	SB6M3-15BS	000-655-985	
A 298	SPACER (2)	HSA-3045	000-803-045	

# FURUNO

## MECHANICAL PARTS LIST

1995-11

MODEL	FR2060S/2862S/2865SW	PAGE
UNIT	RTR-018	M-16
REF. DWG.	C3312-E01-	

SYMBOL	PARTS NAME	TYPE/DWG. NO	CODE NO.	REMARKS
A	301	CHASSIS	03-023-5201-0	100-091-240
A	302	COVER	03-023-5101-0	100-091-210
A	303	RF CHASSIS	03-023-5301-0	100-091-430
A	304	MICRO WAVE CKT CHASSIS	03-023-5401-0	100-091-540
A	305	RF CHASSIS COVER	03-023-5302-0	100-091-440
A	306	FIXING ANGLE	03-023-5303-0	100-091-450
A	307	REINFORCEMENT ANGLE	03-023-5306-0	100-091-480
A	308	MAGNETRON FIXING PLATE	03-023-5308-0	100-091-500
A	309	IF AMP FIXING PLATE	03-023-5311-0	100-091-520
A	310	EARTHING PLATE	03-023-5312-0	100-091-530
A	311	MAGNETRON FIXING ANGLE	03-023-5307-0	100-091-490
A	312	NUT PLATE	03-023-5304-0	100-091-460
A	313	BAND FIXING PLATE	03-023-5309-0	100-091-510
A	314	SCR FIXING BASE	03-017-5311-1	100-062-441
A	315	SCR FIXING PLATE	03-017-5312-0	100-062-450
A	316	HEAT SINK	GE-50	000-108-677
A	317	SPACER	SB8M4-15-BS	000-877-111
A	318	SPACER	HSA-4095	000-804-095
A	319	STICKER (HIGH VOLTAGE)	R-12135-D-0	390-100-010
A	320	LABEL	03-017-5129-0	100-070-600
A	321	FAN GUARD	109-019C	000-102-963
A	322	SPACER	HSA-3015	000-803-015
A	323	HINGE	03-012-5325-0	301-253-250
A	324	STOPPER	03-023-5313-0	100-094-630
A	325	HY MOUNTING PLATE (1)	03-012-5403-0	301-254-030
A	326	HY MOUNTING PLATE (2)	03-012-5404-0	301-254-040
A	327	E-CORNER FIXING PLATE	03-023-5403-0	100-091-560
A	328	MIC FIXTURE	03-023-5406-0	100-091-590
A	329	IF AMP CASE	03-017-5504-0	100-062-700
A	330	IF AMP CASE LID	03-017-5505-0	100-062-710
A	331	IF AMP CASE FIXING PLATE	03-007-5314-0	100-049-110
A	332	AMP CASE FIXTURE	03-017-5507-0	100-088-860
A	333	LABEL	03-017-5506-0	100-070-590
A	334	ADAPTOR	03-012-5402-0	301-254-020
A	335	WAVEGUIDE SEAL	03-005-3155-0	100-025-810
A	336	SHIELD CASE	03-017-5111-2	100-062-162
A	337	HEAT SINK	03-017-5113-1	100-062-181
A	338	PT FIXING PLATE	03-017-5112-0	100-062-170
A	339	PC BOARD FIXING PLATE	03-023-5216-0	100-091-380
A	340	SPACER	HSA-3035	000-803-035
A	341	SPACER (2)	HSA-3045	000-803-045
A	342	METER PANEL	03-023-5208-0	100-091-310
A	343	HINGE FIXING PLATE	03-023-5209-0	100-091-320
A	344	PROTECT PLATE	03-023-5211-0	100-091-330
A	345	SPACER	HSA-4040	000-804-040
A	346	EDGING	CE-024 *1M*	000-570-285
A	347	LABEL (R)	03-017-5611-0	100-062-770
A	348	HINGE	TH-TM-5 BRASS	000-872-005
A	349	EDGING	CE-032 *1M*	000-570-287
A	350	LABEL	03-030-0202-0	100-091-820
A	351	KNOB *WING TYPE*	023-4420 BLACK 21DIA	000-515-311
A	352	KNOB CAP	040-4020 BLACK	000-515-324
A	353	METER PANEL SUPPORT	03-023-5207-0	100-091-300
A	354	CABLE CLAMP	03-010-5108-0	301-051-080
A	355	CLAMP PLATE	03-010-5109-0	301-051-090
A	356	MOUNTING FIXTURE	03-023-5204-0	100-091-270
A	357	MOUNTING FIXTURE	03-023-5202-0	100-091-250
A	358	MOUNTING FIXTURE	03-023-5203-0	100-091-260
A	359	W.G. FLANGE	03-012-5130-0	301-251-300
A	360	BLIND PLATE	03-030-0401-0	100-091-640
A	361	SPRING PIN	4X20 SUS	000-866-185
A	362	CONNECTOR FIXING PLATE	03-017-5115-0	100-062-200
A	363	FAN FIXING PLATE	03-023-5217-0	100-091-390
A	364	COVER SUPPORT	03-023-5205-0	100-091-280
A	365	RF CHASSIS SUPPORT	03-023-5206-0	100-091-290

UNIT	RTR-018		REF. DWG.	C3312-E01-	PAGE	M-17
SYMBOL	PARTS	NAME	TYPE/DWG. NO	CODE NO.	REMARKS	
A	366	FILTER RETAINER	03-023-5218-0	100-091-400		
A	367	BLIND PLATE	03-023-5219-0	100-091-410		
A	368	STOPPER	03-012-5107-0	301-251-070		
A	369	SPRING PIN	4X40 SUS	000-866-191		
A	370	FOOT	03-012-5108-1	301-251-081		
A	371	SPONGE	03-023-5221-0	100-091-420		
A	372	SPACER *B*	SB6M3-15BS	000-655-985		
A	373	SIDE PLATE	03-023-5213-0	100-091-350		
A	374	POWER PACK CASE	03-023-5212-0	100-091-340		
A	375	BOTTOM PLATE	03-023-5214-0	100-091-360		
A	376	TOP PLATE	03-023-5215-0	100-091-370		
A	377	SPACER (2)	HSA-3020	000-803-020		
A	378	CLASP *HOOK & LOCK*	C-1007-2 00S0053-0	000-872-857		
A	379	AIR FILTER	03-023-5103-0	100-091-230		
A	380	AIR FILTER RETAINER	03-023-5102-0	100-091-220		
A	381	NAME PLATE	03-009-0117-1	300-901-171		
A	382	CONNECTOR FIXING PLATE	03-023-5501-0	100-091-620		
A	383	SPACER	SB-6M3-10-BS	000-877-113		
A	384	SPRING PIN	4X8 AW SUS304	000-801-595		
A	385	NUT PLATE	03-023-5305-0	100-091-470		
A	386	BOLT	RRA-3004-0	340-130-040		
A	387	BOBBIN FIXTURE	03-017-5313-0	100-062-460		
A	388	BOBBIN	03-017-5315-0	100-062-480		
A	389	LIMITER FIXTURE	03-023-5402-0	100-091-550		

## ELECTRICAL PARTS LIST 電気部品表

1996- 5

MODEL	FR/FAR-2805 SER.		
UNIT	DISPLAY UNIT 指示部		PAGE
REF. DWG.	C3404-K01-	BLOCK NO.	E-1

SYMBOL	T Y P E	SPECIFICATIONS	CODE NO.	REMARKS
記号	型名	規格	コード番号	備考
PRINTED CIRCUIT BOARD		プリント基板		
	03P9132 HIC8		008-448-520	
	03P9135 HIC11		008-448-530	
	03P9134 HIC10		008-448-550	
	03P9133 HIC9		008-448-560	
1B04A0004	PCT-9106 AC PROTECT	RDP-106	008-447-800	
1B05A0005	03P9111C	FOR JAPANESE	008-460-440	
	03P9111D	FOR ENGLISH	008-460-450	
1B06A0006	MB-9169		008-460-320	
1B07A0007	INT-9170		008-460-310	
1B08A0008	VDA-9114 VIDEO AMP	RDP-106	008-447-690	
1B09A0009	HV9017A, HV	10KW X-BAND	008-419-540	
	HV-9017B TX-HV	25KW X-BAND	008-417-710	
	HV-9017E, HV	30KW S-BAND	008-420-900	
1B10A0010	PAL-9171/TUN9128C/D		008-460-280	
1B11A0011	PAR-9172/TUN9128A		008-460-290	
1B12A0012	PWS-9173		008-460-250	
1B22A0022	18P9002A	FAR-2805	008-460-410	
1B23A0023	03P9164, ECHO		008-460-460	
1B25A0025	64P1106A, GYRO CONV.	GC-7/8/10	004-412-220	
	14P0261B RP		008-467-610	
	14P0262, CARD I/F		008-451-190	
	18P9002A, ARPA		008-460-041	
CRT ASSEMBLY		CRT クミヒツ		
1B14A0001	CDT-2901B-1A		000-136-185	Until JAN. '98
	CRT-2901B-1A		000-137-764	
ASSEMBLY		クミヒツ		
1B03A*0003	RDP-115-60, PTU9187A	POWER	008-460-340	
	RDP-115-72, PTU9187B	POWER	008-460-350	
MOTOR		モーター		
B	1	MMS-08C24DH-R		000-128-410
B	2	MMS-06C24DS-R01	03S9110-0	000-128-409
CAPACITOR		コンデンサー		
C	1	ECQ-E2A474MW		000-104-841
FUSE		ヒューズ		
F	1	FGBO 5A	AC250V	000-549-022 220VAC
		FGBO 10A	AC125V	000-549-065 100/110VAC
F	2	FGBO 5A	AC250V	000-549-022 220VAC
		FGBO 10A	AC125V	000-549-065 100/110VAC
F	3	FGBO 0.5A	AC125V	000-549-060 TX-HV
F	4	FGBO-A 5A AC125V	00S0093-0	000-549-064 SCAN.MOTOR

UNIT	DISPLAY UNIT	REF. DWG.	C3404-K01-	BLOCK NO.	E-1a	2
------	--------------	-----------	------------	-----------	------	---

SYMBOL	T Y P E	SPECIFICATIONS	CODE NO.	REMARKS
記 号	型 名	規 格	コ ー ド 番 号	備 考

FILTER

フィルタ-

FL	1	LF-210	AC/DC250V 10A	000-588-410
----	---	--------	---------------	-------------

TRACKBALL

トラックボール

TB	1	EUA-FTF814B	03S7678-0	000-115-533
----	---	-------------	-----------	-------------

# FURUNO

電気部品表

ELECTRICAL PARTS LIST

98年 12月

Model	FR/FAR-2805 SER.	
Unit	DISPLAY UNIT 指示部	
Ref. Dwg.	C3404-K15-	Page
Blk. No.		E-2

SYMBOL	TYPE	CODE No.	REMARKS	SHIPPABLE ASSEMBLY
回路記号	型式	コード番号	備考	出荷単位組品
<b>PRINTED CIRCUIT BOARD</b>		<b>プリント基板</b>		
	PBG-972-974-915 (CDT2901B-1A)	000-137-758	旧CRT用, For CRT used lately	○
	PBG-973, VIDEO (CDT2901B-1A)	000-137-759	旧CRT用, For CRT used lately	○
	PBG-975, POWER (CDT2901B-1A)	000-137-760	旧CRT用, For CRT used lately	○
	29CF CRT(S)ASS (CDMC29CF301)	000-790-226	added in 1/99 追加 現流CRT用, For CRT used currently	○
	CDUC-29CF301 PS(S) (CDMC29CF301)	000-790-227	added in 1/99 追加 現流CRT用, For CRT used currently	○
	CDUC-29CF301 MAIN(S) (CDMC29CF301)	000-790-229	added in 1/99 追加 現流CRT用, For CRT used currently	○
<b>COIL</b>		<b>コイル</b>		
	PCL62-09	000-137-761		
<b>TRANSISTOR</b>		<b>トランジスタ</b>		
	HPA72R	000-137-762		
<b>TRANSFORMER</b>		<b>トランス</b>		
	PCF72-01 (CDT2901B-1A)	000-137-763	旧CRT用, For CRT used lately	
	FBT-2436469 (FB) (CDMC29CF301)	000-790-228	added in 1/99 追加 現流CRT用, Currently used.	○



# FURUNO

## 電気部品表

### ELECTRICAL PARTS LIST

98年 5月

Model	FR-2115/2125	
Unit	空中線部	RSB-0074/0075
	SCANNER UNIT	
Ref. Dwg.	C3466-K02-B	Page
Blk. No.		E-3

SYMBOL	TYPE	CODE No.	REMARKS	SHIPPABLE ASSEMBLY
回路記号	型式	コード番号	備考	出荷単位組品
<b>PRINTED CIRCUIT BOARD</b>		<b>プリント基板</b>		
2B2	03P9243A, RFC	008-487-260	FR-2115	○
	03P9243B, RFC	008-487-280	FR-2125	○
2B3	03P9244A, MD	008-487-300	FR-2115	○
	03P9244B, MD	008-487-320	FR-2125	○
2B4	03P9232, IF	008-487-240		○
2B6	03P9242, TB	008-487-230		○
2B7	MP-3795	008-312-370		○
<b>SCANNER CHASSIS</b>		<b>空中線筐体部</b>		
	RSB-0074	008-488-010	24rpm, w/o RF module	○
	RSB-0075	008-488-030	42rpm, w/o RF module	○
<b>RF MODULE</b>		<b>RFモジュール</b>		
	RTR-062	008-487-160	Except Japan 日本を除く	○
	RTR-063A	008-490-680	Japan only 日本のみ	○
	RTR-063	008-487-170		○
<b>MIC ASEMBLY</b>		<b>MIC組品</b>		
U801	RU-9253	008-487-350	RTR-063	○
	RU-9371	008-487-340	RTR-062	○
<b>MOTOR</b>		<b>モーター</b>		
B801	D8G-516	000-631-715	24rpm, w/capacitor	
	D8G-571	000-136-566	42rpm, w/capacitor	
B802	109P0824H602	000-140-764	25kW, w/cable	○
<b>SWITCH</b>		<b>スイッチ</b>		
S901	RS-1 NO	000-478-301		
<b>DIODE</b>		<b>ダイオード</b>		
CR870	HVR-1X-40B	000-121-156	FR-2115	
	MD-12N1	000-133-735	FR-2125	
CR871	HVR-1X-40B	000-121-156		
<b>DIODE LIMITER</b>		<b>ダイオードリミター</b>		
CR880	RU-9099	000-126-369		
<b>CIRCULATOR</b>		<b>サーキュレータ</b>		
HY801	RC-3686	000-106-850		

SYMBOL	TYPE	CODE No.	REMARKS	SHIPPABLE ASSEMBLY
回路記号	型式	コード番号	備考	出荷単位組品
<b>RESISTOR</b>		<b>抵抗</b>		
R899	ERF-10HMJ102	000-123-395		
<b>TRANSFORMER</b>		<b>トランス</b>		
T801	RT-9025	000-123-823	FR-2115	
	RT-9023	000-123-394	FR-2125	
<b>MAGNETRON</b>		<b>マグネトロン</b>		
V801	MG5241	000-100-036	FR-2115 Except Japan	日本を除く
	E3566	000-141-073	FR-2115 Japan only	日本のみ
	MG5436	000-140-762	FR-2125	
<b>CABLE ASSEMBY</b>		<b>ケーブル組品</b>		
W1	03-1903(2-R2P)	008-486-910		
W2	03-1904(13-13P)	008-486-920		

# FURUNO

## 電気部品表

### ELECTRICAL PARTS LIST

99年 1月

Model	FR-2125W	
Unit	空中線部	RSB-0076/77/78
	SCANNER UNIT	
Ref. Dwg.	C3333-K01-	Page
Blk. No.		E-9

SYMBOL	TYPE	CODE No.	REMARKS	SHIPPABLE ASSEMBLY
回路記号	型式	コード番号	備考	出荷単位組品
<b>PRINTED CIRCUIT BOARD</b>		<b>プリント基板</b>		
2B3	MP-8161, MP	008-391-430		
2B4	BP-8162, BP	008-391-450		
2B5	MPT-8226, MPT	008-391-420		
2B6	03P9263, DE-1 CER	008-500-090	OPTION	
<b>MOTOR</b>		<b>モーター</b>		
B801	RM-8123	000-117-822	200/220VAC, 3φ :RSB-0076	
	RM-8124	000-117-823	380/440VAC, 3φ :RSB-0077	
	RM-8247	000-117-824	100VAC, 1φ :RSB-0078	
<b>SWITCH</b>		<b>スイッチ</b>		
S801	RS-1 N0	000-478-301		
S802	ATK21-W	000-478-301		
S3001	TR-8B50PDS2	000-478-160		
<b>DIODE</b>		<b>ダイオード</b>		
CR3001	BCR-16C10RS	000-141-122		
<b>RESISTOR</b>		<b>抵抗</b>		
R3004	ERD-25PJ221	000-330-341		

## ELECTRICAL PARTS LIST 電気部品表

1996- 3

MODEL	FR/FAR-2825W		
UNIT	TRANSCEIVER UNIT 送受信部 RTR-046		PAGE
REF. DWG.	C3405-K01-B	BLOCK NO.	E-10

SYMBOL 記号	T Y P E 型名	SPECIFICATIONS 規格	CODE NO. コード番号	REMARKS 備考
PRINTED CIRCUIT BOARD		プリント基板		
1B03A0003	RF	RTR-046	008-465-420	
1B05A0005	03P9189,INT	RTR-046/047	008-470-800	
1B06A0006	RFC-9008D,RFC	RTR-046	008-470-820	
1B07A0007	MD-9009,MD	RTR-029/046	008-470-840	
1B08A0008	PTU-9185A,PTU	RTR-046/047	008-465-450	AC100/115V
	PTU-9185B,PTU	RTR-046/047	008-465-480	AC220/230V
1B09A0009	IF-9007,IF	FR/FAR-2825W	008-465-490	
1B10A0010	MIC-6550,MIC	RTR-046	008-465-470	
-----				
MOTOR		モーター		
B 801	MMS-08C24DH-R		000-128-410	
CAPACITOR		コンデンサー		
C 890	ECQ-V1H104JLW		000-129-101	
DIODE		ダイオード		
CR 871	MD-12N1		000-133-735	
CR 880	RU-9290	03S9290-0	000-136-735	
FUSE		ヒューズ		
F 801	FGBO 0.5A	AC125V	000-549-060	
F 802	FGBO-A	2A,AC125V	000-549-062	
FILTER		フィルター		
FL 801	LF-205A	13-3-5363	000-588-411	
HIGH VOLTAGE PACK		コウアツパツク		
HY 801	RC-3686	13-3-3686-2	000-106-850	
JACK		ジャック		
J 810	WF3003E	13-3-5387	000-518-022	
TRANSISTOR		トランジスター		
Q 808	2SB1259		000-116-180	
RESISTOR		抵抗		
R 889	ERF-10HMJ102		000-123-395	
TRANSFORMER		トランス		
T 801	RT-9023	03S9023-0	000-123-394	

SYMBOL	T Y P E	SPECIFICATIONS	CODE NO.	REMARKS
記号	型名	規格	コード番号	備考
	TRANSFORMER			
		トランス		
T 801	RT-9023	03S9023-0	000-123-394	
	TERMINAL BOARD			
		ターミナルボード		
TB 801	STK-A8		000-135-509	
	INTEGRATED CIRCUIT			
		シリウセキカイロ		
U 801	S-RX24,03S6756		000-106-856	
	ELECTRON TUBE			
		真空管		
V 801	M5187(F)		000-101-760	

## ELECTRICAL PARTS LIST 電気部品表

1995-11

MODEL	FR-2150W/2852X/2855W		
UNIT	TR UNIT RTR-010		PAGE
REF. DWG.	C3300-005-	BLOCK NO.	2B

E-12

SYMBOL 記号	T Y P E 型名	SPECIFICATIONS 規格	CODE NO. コード番号	REMARKS 備考
2B03	03P-6666B RTB	FR-2050X/2150W	008-256-220	
2B04	03P6668 PFN-1		008-256-140	
2B05	03P-6669 PFN-2	FR-2050X/2150W	008-256-230	
2B06	03P-6827 MAG	FR-2050X/2150W	008-256-240	
2B07	03P-6667 PWR	FR-2050X/2150W	008-256-210	
2B08	03P-6680 HV-1	FR-2050X/2150W	008-256-180	W/ 03P6810
	03P-6810 HV-2	FR-2050X/2150W	008-256-190	
2B09	CM-5146DRTR-010		008-256-160	
2B10	IF-6734E	RTR-019-3	008-457-150	
	TX MODULE	RTR-010	008-234-240	TX MODULE
-----				
MOTOR		モーター		
2B01B0801	109S005		000-430-454	
2B01B0802	109S005		000-430-454	
CAPACITOR		コンデンサ		
2B02C0801	ECK-D3D222KBN	2200PF 2KV	000-257-308	
2B02C0804	MD-1-2E-104M	0.1UF 250VV	000-262-001	
2B02C0851	DD104-69B102K50V	1000PF 50V	000-253-806	
2B02C0852	DD106F103Z50 N5.0	0.01UF 50V	000-253-443	
DIODE		ダイオード		
2B02CR0803	V19E		000-136-020	
2B02CR0804	V19E		000-136-020	
2B02CR0805	V19E		000-136-020	
2B02CR0808	ED-16H1	13-3-2643-0	000-132-550	
2B02CR0809	ED-16H1	13-3-2643-0	000-132-550	
2B02CR0810	E3902		000-105-620	
	BS4122		000-108-889	
2B02CR0813	SH16J12U		000-135-165	
2B02CR0814	SH16J12U		000-135-165	
2B02CR0815	SH16J12U		000-135-165	
2B02CR0851	RD-6.2EB	ZENER	000-134-793	
LAMP		ランプ		
2B01DS0801	BN-5668 AC100V	RED	000-541-711	
FUSE		ヒューズ		
2B01F0801	FGBO-A 5A AC125V	00S0093-0	000-549-064	
2B01F0802	FGBO-A	2A,AC125V	000-549-062	
2B01F0803	FGBO-A	2A,AC125V	000-549-062	



UNIT	TR	UNIT	RTR-010	REF. DWG.	C3300-005-	BLOCK NO.	2B E-14
------	----	------	---------	-----------	------------	-----------	---------

SYMBOL	T Y P E	SPECIFICATIONS	CODE NO.	REMARKS
記 号	型 名	規 格	コード番号	備 考

ELECTRON TUBE

テ管シカソ

2B02V0801 M4505E

13-3-18201

000-106-012



# FURUNO

## 電気部品表

### ELECTRICAL PARTS LIST

2001年 6月

Model	FR-2835S	
Unit	空中線部	RSB-0026/0031/0088/0089/0090
	SCANNER UNIT	
Ref.Dwg.	C3469-K01-B	Page
Blk.No.		E-15

SYMBOL	TYPE	CODE No.	REMARKS	SHIPPABLE ASSEMBLY
回路記号	型式	コード番号	備考	出荷単位組品
<b>PRINTED CIRCUIT BOARD</b>		<b>プリント基板</b>		
1B2	03P9243D, RFC	008-488-220		X
1B3	03P9244C, MD	008-488-230		X
1B4	03P9232A, IF	008-488-240		X
1B6	03P9242, TB	008-487-230		
1B7	MP-7302	008-256-330		X
1B8	MSS-7497	008-243-530	200/220VAC	X
	MSS-7497A	008-243-540	380/440VAC	X
<b>ASSEMBLY</b>		<b>組品</b>		
U801	RSB-0026/31-066	008-491-530	AMP/MIC	X
	RSB-0026/31-066	008-491-580	MIC RU-9427	X
	RSB-0026/31-066	008-493-020	TR CHASSIS, RFC, MD	X
<b>SCANNER CHASSIS</b>		<b>空中線筐体部</b>		
	RSB-0026-066-N	008-493-470		X
	RSB-0026-066-I	008-493-480		X
	RSB-0026-066-N-HK	008-493-490		X
	RSB-0026-066-I-HK	008-493-500		X
	RSB-0031-066-N	008-493-510		X
	RSB-0031-066-I	008-493-520		X
	RSB-0031-066-N-HK	008-493-530		X
	RSB-0031-066-I-HK	008-493-540		X
	RSB-0088-066-N	008-525-300		
	RSB-0088-066-I	008-525-400		
	RSB-0089-066-N	008-525-050		
	RSB-0089-066-I	008-525-060		
	RSB-0090-066-N	008-525-070		
	RSB-0090-066-I	008-525-080		
<b>MOTOR</b>		<b>モーター</b>		
B801	RM-7398	000-113-840	200/220VAC, 50/60Hz	
	RM-7435	000-114-399	440/380VAC, 50/60Hz	
B802	109E1224M102	000-109-412		
	RM-9519	000-144-850	220VAC, 50Hz	
	RM-9520	000-144-851	220VAC, 60Hz	
	RM-9521	000-144-852	440VAC, 60Hz	
<b>CAPACITOR</b>		<b>コンデンサ</b>		
C890	ECQ-V1H104JL3	000-129-260		
<b>TRANSISTOR</b>		<b>トランジスタ</b>		
Q15	2SB946P	000-133-053		

SYMBOL	TYPE	CODE No.	REMARKS	SHIPPABLE ASSEMBLY
回路記号	型式	コード番号	備考	出荷単位組品
<b>DIODE</b>		<b>ダイオード</b>		
CR870	MD-12N1	000-133-735		
CR871	HVR-1X-40B	000-121-156		
CR880	RU-9426	000-141-060	DIODE LIMITTER	
CR3001	BCR-16C10R	000-132-186	DEICER	
<b>HEATER</b>		<b>ヒーター</b>		
HR3001	NDO-50040, 60W	000-633-409	DEICER	
HR3002	NDO-50040, 60W	000-633-409	DEICER	
<b>RESISTOR</b>		<b>抵抗</b>		
R899	1K/10	000-123-823		
R3004	ERD-25PJ221	000-330-341	DEICER	
<b>SWITCH</b>		<b>スイッチ</b>		
S801	RS01, NO	000-478-301		
S802	ATK21-W	000-479-243		
S3001	TR-8B50-PDS2	000-478-160	DEICER	
<b>TRANSFORMER</b>		<b>トランス</b>		
T801	RT-9273	000-136-734	PULSE TRANS.	
<b>CIRCULATOR</b>		<b>サーキュレータ</b>		
HY801	RC-6584S	000-126-345		
<b>MAGNETRON</b>		<b>マグネトロン</b>		
V801	MG5223F	000-109-081		
<b>ROTARY ENCODER</b>		<b>ロータリ-エンコーダ</b>		
U802	RE20F-120-100-B	000-113-271		
<b>w/CONNECTOR ASSY.</b>		<b>コネクタ組品</b>		
	03-1967(P2P)	008-491-450		
	03-1965(3P)	008-491-420		
	03-1969(6P)	008-491-470		
	03-4966(13-13P)	008-491-430		
	03-1969(6P)	008-491-470		

## ELECTRICAL PARTS LIST 電気部品表

1996- 3

MODEL	FR2160SW/2835SW/65SW		
UNIT	SCANNER UNIT		PAGE
REF. DWG.	C3312-014-	BLOCK NO.	1B
			E-17

SYMBOL 記号	TYPE 型名	SPECIFICATIONS 規格	CODE NO. コード番号	REMARKS 備考
1B02	MP-7302		008-256-330	
1B03	MSS-7497	FOR 200/220V	008-243-530	220/200V
	MSS-7497.A	FOR 380/440V	008-243-540	440/380V
-----				
MOTOR		モーター		
1B01B0801	RM-7398	03S7398	000-113-840	220VAC
	RM-7435	03S7435	000-114-399	440VAC
DIODE		ダイオード		
1B15CR3001	BCR-16C10R		000-132-186	DEICER
HEATER		ヒーター		
1B15HR3001	NDO-50040,60W	13-3-3409	000-633-409	DEICER
1B15HR3002	NDO-50040,60W	13-3-3409	000-633-409	DEICER
RESISTOR		抵抗		
1B15R3004	ERD-25PJ221	0.25W 220	000-330-341	DEICER
SWITCH		スイッチ		
1B01S0801	RS-1,N0	13-3-2799	000-478-301	
1B01S0802	ATK21-W		000-479-243	
1B15S3001	TR-8B50-PDS2	13-3-4962	000-478-160	DEICER
INTEGRATED CIRCUIT		シロウセキカイロ		
1B01U0801	ENCODER ASSY	RSB-0026	008-256-320	RE20F-120-100-B

## ELECTRICAL PARTS LIST 電気部品表

1996- 3

MODEL	FR/FAR-2835SW		
UNIT	TRANSCIVER UNIT 送受信部 RTR-047		PAGE
REF. DWG.	C3408-K01-A	BLOCK NO.	E-18

SYMBOL 記号	T Y P E 型名	SPECIFICATIONS 規格	CODE NO. コード番号	REMARKS 備考
PRINTED CIRCUIT BOARD		プリント基板		
1B03A0003	03P9189,INT	RTR-046/047	008-470-080	
1B04A0004	RFC-9008E,RFC	RTR-046	008-470-830	
1B05A0005	MD-9009A,MD	RTR-047	008-470-850	
1B06A0006	PTU-9185A,PTU	RTR-046/047	008-465-450	AC100/115/ 220/230V
	PTU-9185B,PTU	RTR-046/047		
1B07A0007	IF-9007	RTR-047	008-465-780	
1B09A0009	MIC/ATT-7362	RTR-047	008-465-730	B8
-----				
MOTOR		モーター		
B 801	MMS-06C12DS-R02	03S9109-0	000-128-408	
CAPACITOR		コンデンサー		
C 890	ECQ-V1H104JLW		000-129-101	
DIODE		ダイオード		
CR 870	MD-12N1		000-133-735	
CR 871	MD-12N1		000-133-735	
FUSE		ヒューズ		
F 801	FGBO 0.5A	AC125V	000-549-060	
F 802	FGBO-A	2A,AC125V	000-549-062	
FILTER		フィルター		
FL 801	LF-205A	13-3-5363	000-588-411	
HIGH VOLTAGE PACK		コウアツハツク		
HY 801	RC-4910S	13-3-4910-2	000-126-346	
JACK		ジャック		
J 810	WF3003E	13-3-5387	000-518-022	
TRANSISTOR		トランジスタ		
Q 808	2SB1259		000-116-180	
RESISTOR		抵抗		
R 889	ERF-10HMJ102		000-123-395	
TRANSFORMER		トランス		
T 801	RT-9273-0	03S9273-0	000-136-734	

SYMBOL	T Y P E	SPECIFICATIONS	CODE NO.	REMARKS
記号	型名	規格	コード番号	備考
	TRANSFORMER			
T 801	RT-9273-0	03S9273-0	000-136-734	
	TERMINAL BOARD			
TB 801	STK-A8		000-135-509	
	ELECTRON TUBE			
V 801	MG5223F	S-BAND	000-109-081	

## ELECTRICAL PARTS LIST 電気部品表

1996- 3

MODEL	FR-2160SW/2865SW		
UNIT	TR UNIT RTR-018		PAGE
REF. DWG.	C3409-K01-	BLOCK NO.	2B00
			<b>E-20</b>

SYMBOL 記号	T Y P E 型名	SPECIFICATIONS 規格	CODE NO. コード番号	REMARKS 備考
2B02	RTR-018	FR-2060S/62S	008-173-840	INCL. IF AMP ETC.
2B03	03P6666A	FR-2060S/2160SW	008-173-870	
2B04	03P6668 PFN-1		008-256-140	
2B05	03P6669A PFN-2	FR-2060S/2160SW	008-256-150	
2B06	03P6827.A	FR-2060S/2160SW	008-256-110	
2B07	03P6667	FR-2060S/2160SW	008-173-880	
2B08	03P6680/03P6810	RTR-018	008-173-850	
	03P6680	FR-2060S/2160SW	008-256-280	
	03P6810	FR-2060S/2160SW	008-256-270	
2B09	CM-5146DRTR-010		008-256-160	
2B10	IF-6734D	RTR-018/025-3	008-457-180	
	CM-5146C/TRT-7363	RTR-018	008-173-860	W/ B9(CM) & B14(TRT)
-----				
MOTOR		モーター		
2B01B0801	109S005		000-430-454	
2B02B0802	109S005		000-430-454	
CAPACITOR		コンデンサー		
2B02C0801	ECK-D3D222KBN	2200PF 2KV	000-257-308	
2B02C0804	MD-1-2E-104M	0.1UF 250WV	000-262-001	
DIODE		ダイオード		
2B01CR0061	TLR143K		000-100-146	
2B01CR0062	TLR143K		000-100-146	
2B02CR0803	V19E		000-136-020	
2B02CR0804	V19E		000-136-020	
2B02CR0805	V19E		000-136-020	
2B02CR0808	ED-16H1	13-3-2643-0	000-132-550	
2B02CR0809	ED-16H1	13-3-2643-0	000-132-550	
2B02CR0810	BS894	S-BAND	000-105-100	TR TUBE
2B02CR0813	SH16J12U		000-135-165	
2B02CR0814	SH16J12U		000-135-165	
2B02CR0815	SH16J12U		000-135-165	
FUSE		ヒューズ		
2B01F0801	FGBO-A 5A AC125V	00S0093-0	000-549-064	
2B01F0802	FGBO-A	2A, AC125V	000-549-062	
2B01F0803	FGBO-A	2A, AC125V	000-549-062	
FILTER		フィルター		
2B01FL0801	LF-205A	13-3-5363	000-588-411	

SYMBOL	T Y P E	SPECIFICATIONS	CODE NO.	REMARKS
記号	型名	規格	コード番号	備考
HOUR METER		アワーメーター		
2B01HM0801	HM-5-106	HOUR METER	000-440-923	
HIGH VOLTAGE PACK		コウツハ°ツク		
2B02HY0801	RC-4910	13-3-4910-1	000-106-862	
RELAY		リレー		
2B02K0801	VF-12HN		000-108-676	
2B02K0802	VF-12HN		000-108-676	
2B02K0803	VF-12HN		000-108-676	
COIL		コイル		
2B02L0801	RL-6772-1	03S6772-1	000-108-655	
METER		メーター		
2B01M0801	SH48#3075	RP1892-3	000-631-892	
RESISTOR		テイコウ		
2B02R0801	FGO	10W 1K	000-357-360	
2B02R0802	ERG-2ANJ6R8	2W,6.8	000-113-843	
2B01R0811	FGOS	10W,4	000-360-035	
2B01R0812	FGOS	10W,2	000-360-036	
2B02R0826	GS-1 J	4.7M	000-108-671	
2B02R0827	GS-1 J	4.7M	000-108-671	
2B02R0828	GS-1 J	4.7M	000-108-671	
SWITCH		スイッチ		
2B01S0801	22AC-J5		000-473-400	
2B01S0802	22AC-J5		000-473-400	
TRANSFORMER		トランス		
2B02T0801	RT-6991	03S6991-1	000-113-272	
2B02T0804	RT-6670-1	03S6670-1	000-108-661	
INTEGRATED CIRCUIT		シリウセキカイロ		
2B02U0801	MIC ASSY	RTR-018	008-256-120	W/B13(ATT)
ELECTRON TUBE		テ°ンシカン		
2B02V0801	MG5240	S-BAND	000-100-240	

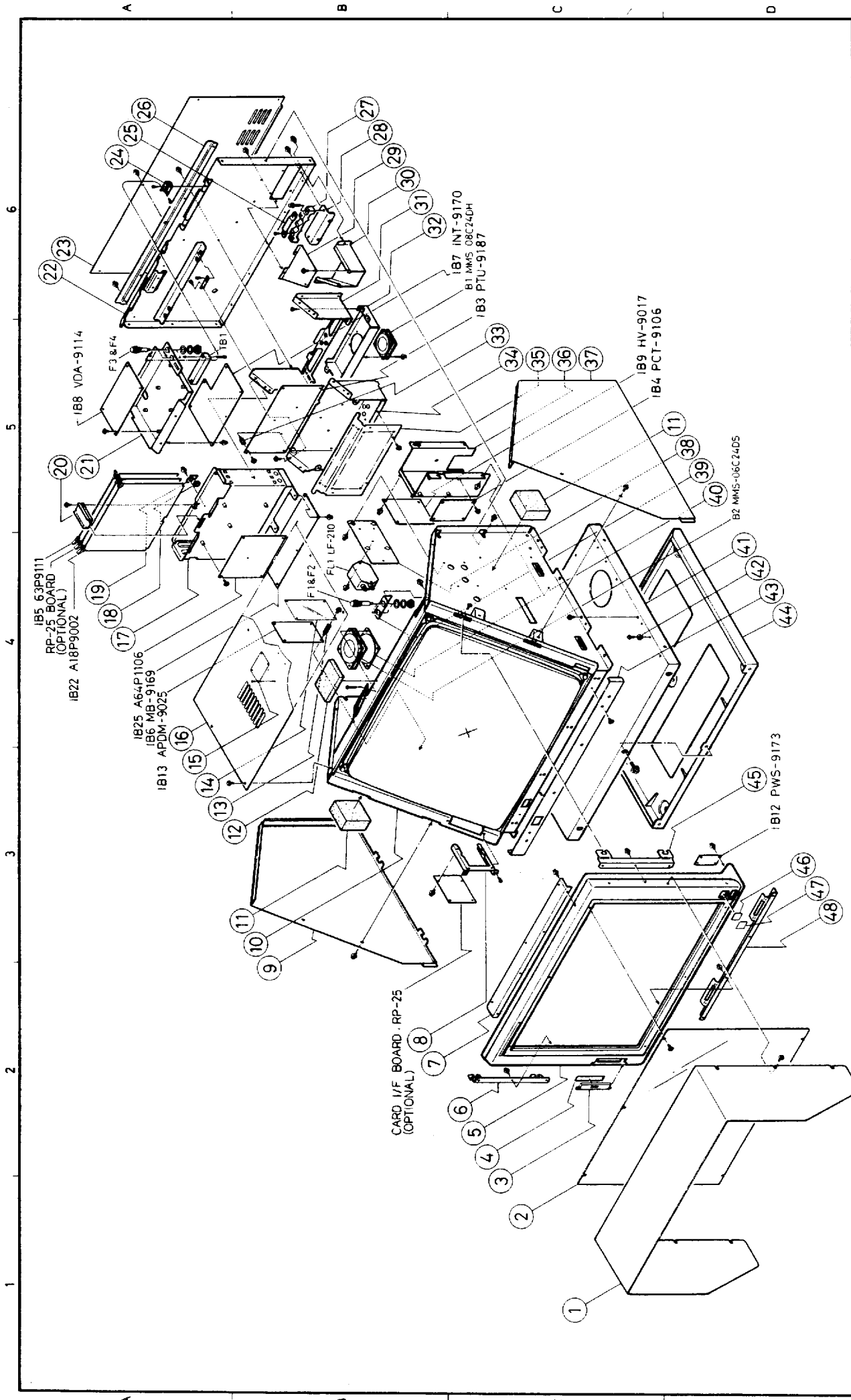

APPROVED	DATE	TITLE
K. Okamoto	July 6 '75	RDP-115
CHECKED	DATE	DWG. NO.
H. Maki	July 6 '75	C3418-E01-A
DRAWN	DATE	
E. Miyoshi		

FA-2805  
 FR/FAR-2815/2825/2855  
 FR/FAR-2835S/2825W/2855W  
 FR/FAR-2835SW/2865SW

1 2 3 4 5 6

A B C D



1 2 3 4

A

B

C

D

E

F

A

B

C

D

E

F

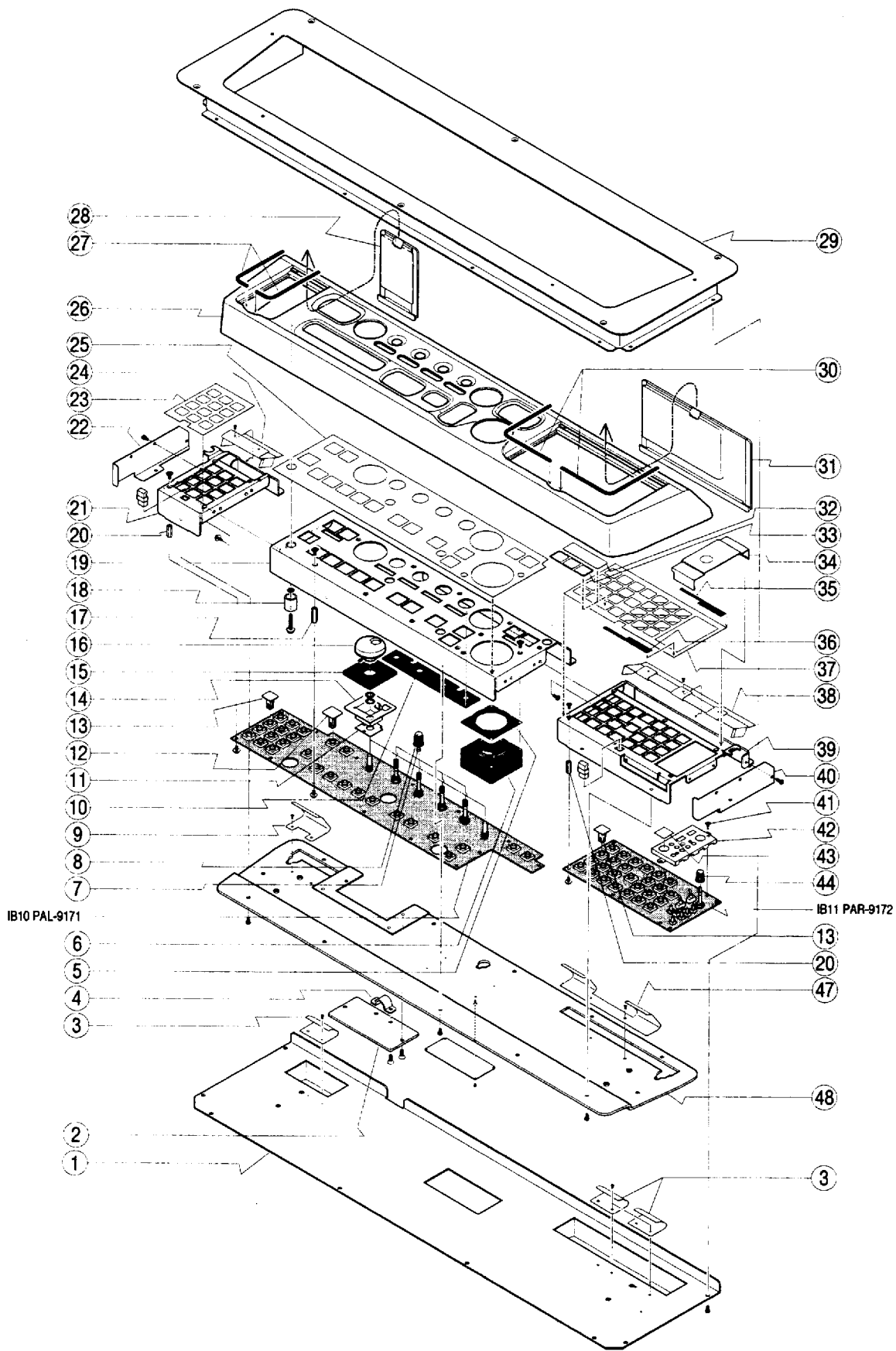

IB10 PAL-9171

IB11 PAR-9172

DRAWN Aug. 30. 76 H. MAKI				TYPE FR/FAR-2805	
CHECKED Aug 30 76 K OKAMOTO				名称 操作部	
APPROVED Aug 30 76 K OKAMOTO				分解図	
SCALE	1/1	MASS	kg	APPLICABLE TO: (MODEL)	BLOCK NO.
DWG. NO. C3404-E01-A				NAME CONTROL UNIT	
EXPLODED VIEW					

RADIATOR ASSY.

FR-2115/2125/2125V: XN-20AF, XN24AF  
 FR-1505/1510/1525 MK-3: XN-12AF, XN-20AF  
 FR-1710: XN-12AF, XN-20AF  
 FR-1725: XN-20AF, XN-24AF

輻射部組立品  
 RADIATOR ASSY.  
 XN-12AF (008-485-250)  
 XN-20AF (008-485-260)  
 XN-24AF (008-485-270)

RFモジュール  
 RF MODULE

FR-2115	RTR-062/062A
FR-2125/2125V	RTR-063
FR-1505 MK-3	RTR-067
FR-1510 MK-3	RTR-062/062A
FR-1525 MK-3	RTR-063
FR-1710	RTR-062/062A
FR-1725	RTR-063

RTR-062A: Japan only (日本のみ)  
 RTR-062: Except Japan (日本を除く)

回転結合器  
 ROTARY JOINT  
 RSB-0074/0075  
 (008-487-200)

アンテナ取付台組品  
 ANTENNA FIXING BASE ASSY.  
 RSB-0074/0075  
 (008-487-190)

アンテナ取付台  
 ANTENNA FIXING PLATE  
 03-144-3201  
 (100-264-100)

カバー用パッキン  
 GASKET  
 03-011-3263  
 (300-132-631)

スキャナーカバー  
 SCANNER COVER  
 03-001-3261  
 (300-132-613)

Vリング A  
 V-RING  
 VR-120A  
 (000-850-738)

シーリング  
 SEAL RING  
 03-001-3222  
 (300-132-221)

深溝玉軸受け  
 BEARING  
 6013ZZ  
 (000-802-338)

リードスイッチ調整板  
 REED SWITCH MOUNT  
 RSK-2108  
 (361-121-081)

駆動ギヤ  
 DRIVE GEAR  
 03-001-3232  
 (300-132-334)

ベアリング  
 BEARING  
 6013ZZ (000-802-338)

変更ギヤ  
 7X7X23 (000-866-851)

マグネット  
 MAGNET  
 RP-1757 MS4X9X15 (000-499-055)

従動ギヤ  
 SCANNER TURNING GEAR  
 03-001-3243 (300-132-412)

モーター取付台  
 MOTOR FIXING PLATE  
 03-001-3231  
 300-132-317

カバー用パッキン  
 COVER GASKET  
 03-001-3263  
 (300-132-631)

締め付け台  
 TURNING GEAR FLANGE  
 RSI-2002 (360-920-021)

スライドレール  
 SLIDE RAIL  
 RSK-2401  
 (361-124-011)

パッキン押さえ  
 CABLE CLAMPING  
 FLANGE  
 03-001-3213  
 (300-132-131)

スキャナー本体  
 SCANNER SOUSING  
 03-001-3212  
 300-132-123

RFモジュール  
 RF MODULE  
 RTR-062 (008-487-160)  
 RTR-062A (008-490-680)  
 RTR-063 (008-487-170)  
 RTR-067 (008-490-580)

スキャナーカバー  
 SCANNER COVER  
 03-001-3261  
 300-132-613

パッキン  
 PACKING  
 JISF8801 25C  
 (000-804-901)

ロッカーチェーン  
 CHAIN  
 ST-16  
 000-841-394

FR-2115/2125  
 FR-2125V  
 FR-1505/1510/1525 MK-3  
 FR-1710/1725

APPROVED	Jan. 22 '99 TAKAHASHI	TITLE	空中線部 ANTENNA UNIT
CHECKED	Jan. 22 '99 TAKAHASHI	RSB-0074/0075	
DRAWN	Jan. 22 '99 E. MIYOSHI	DWG. NO.	C3464-E04-D

1

2

3

4

A

A

B

B

C

C

D

D

E

E

F

F

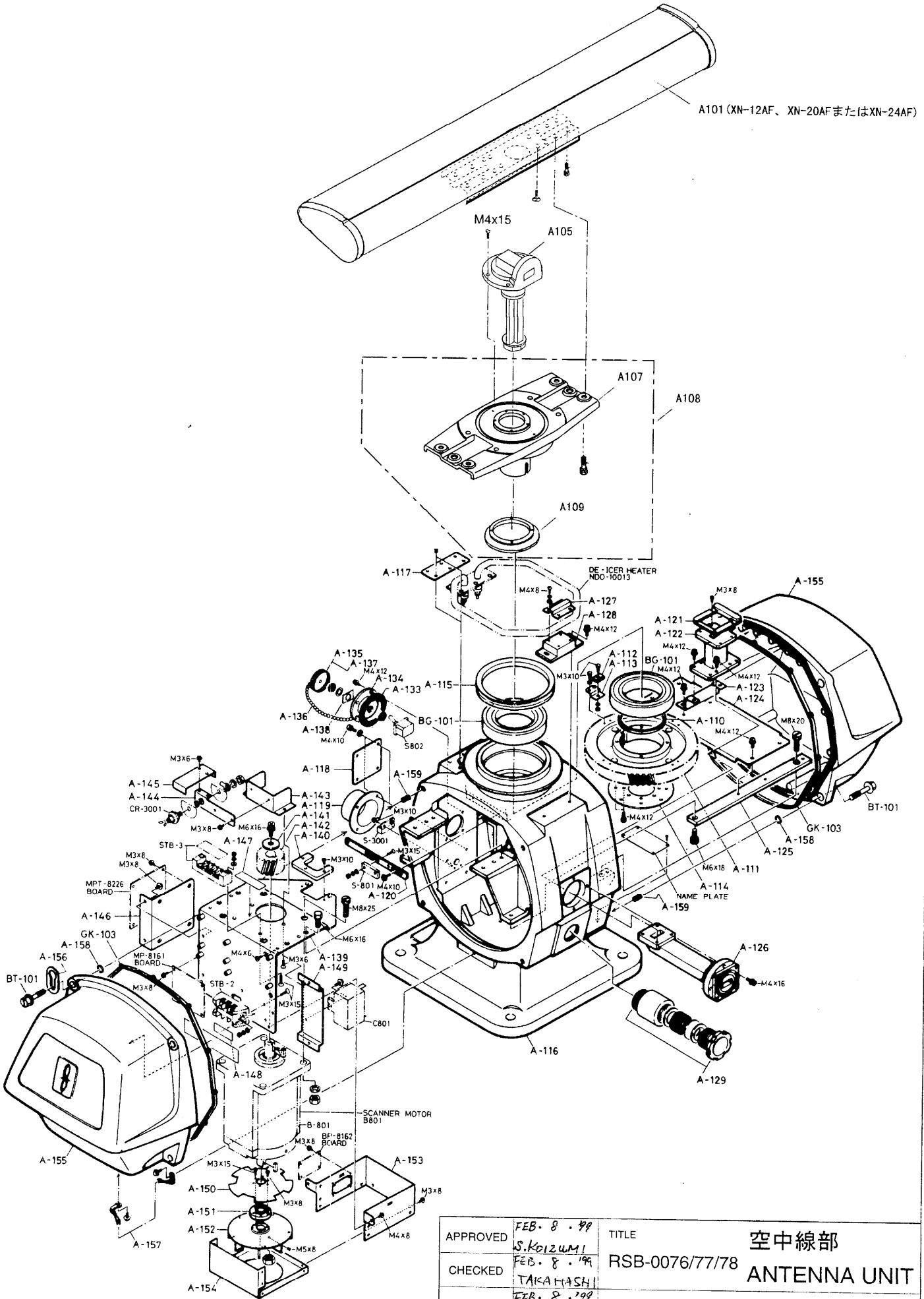

FR-2125W

APPROVED	FEB. 8 '99 S. KOIZUMI	TITLE	空中線部 ANTENNA UNIT
CHECKED	FEB. 8 '99 TAKAHASHI	RSB-0076/77/78	
DRAWN	FEB. 8 '99 E. MIYASHI	DWG. NO.	C3466-E01-A

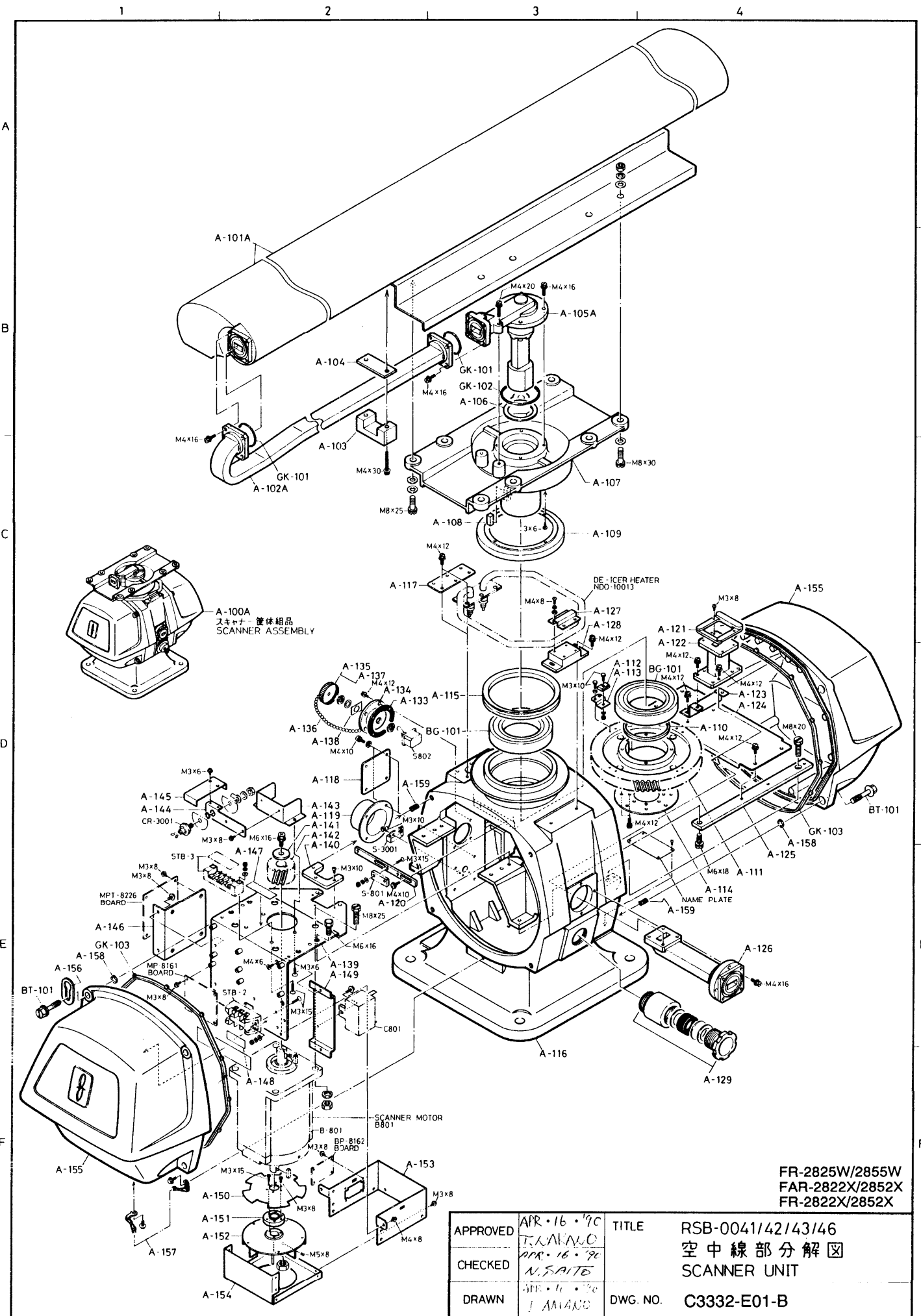

FR-2825W/2855W  
 FAR-2822X/2852X  
 FR-2822X/2852X

APPROVED	APR. 16 '90 <i>T. YAMAGUCHI</i>	TITLE	RSB-0041/42/43/46 空中線部分解図 SCANNER UNIT
CHECKED	APR. 16 '90 <i>N. SAITO</i>	DWG. NO.	C3332-E01-B
DRAWN	APR. 16 '90 <i>I. AMANO</i>		

1 2 3 4

A  
B  
C  
D  
E  
F

A  
B  
C  
D  
E  
F

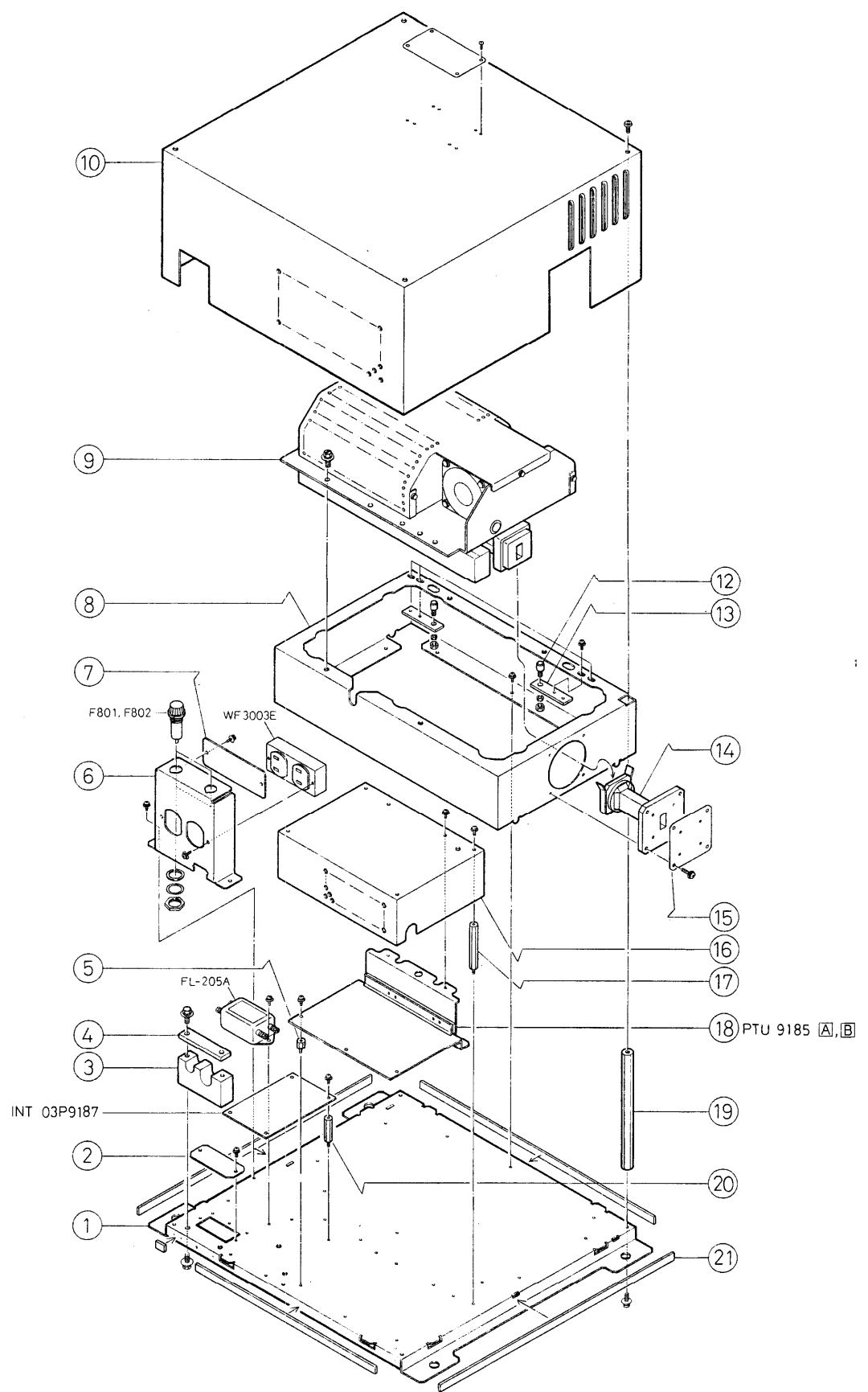

APPROVED	<i>Oct. 25. 1955</i> <i>K Okamoto</i>	TITLE	送受信部
CHECKED	<i>Oct. 25. 1955</i> <i>K Okamoto</i>	RTR-046	TRANSCEIVER UNIT
DRAWN	<i>Oct. 25. 1955</i> <i>T. Nishitani</i>	DWG. NO.	C3405-E01-D

FR-2125W  
FR/FAR-2825W

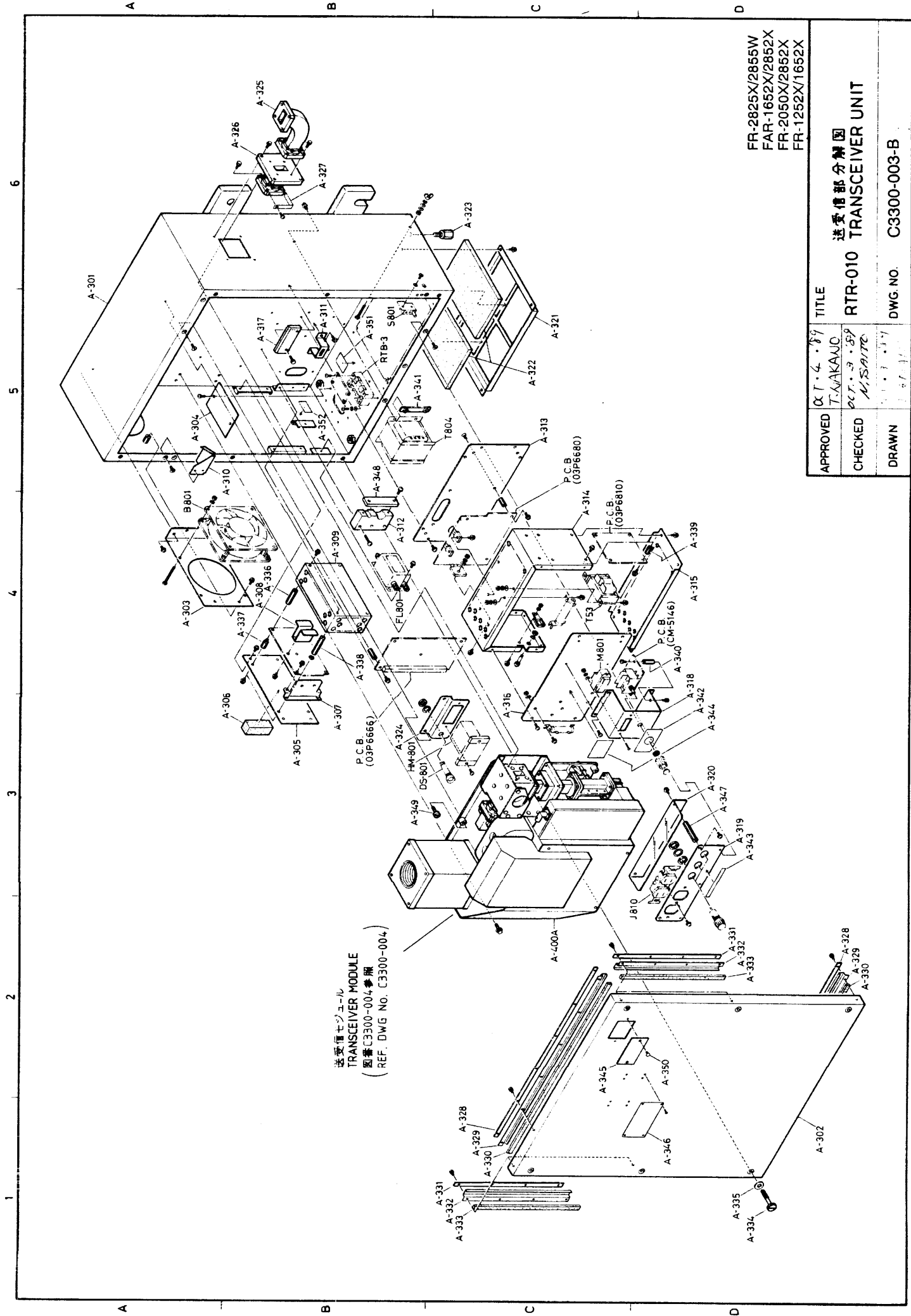

送受信モジュール  
 TRANSCIVER MODULE  
 (図番 C3300-004 参照  
 REF. DWG NO. C3300-004)

FR-2825X/2855W  
 FAR-1652X/2852X  
 FR-2050X/2852X  
 FR-1252X/1652X

APPROVED	α T. 4. 89	TITLE	RTR-010 TRANSCIVER UNIT
CHECKED	T. YAKAUC		
DRAWN	Oct. 9. 89		
	M. SAITO		
		DWG. NO.	C3300-003-B

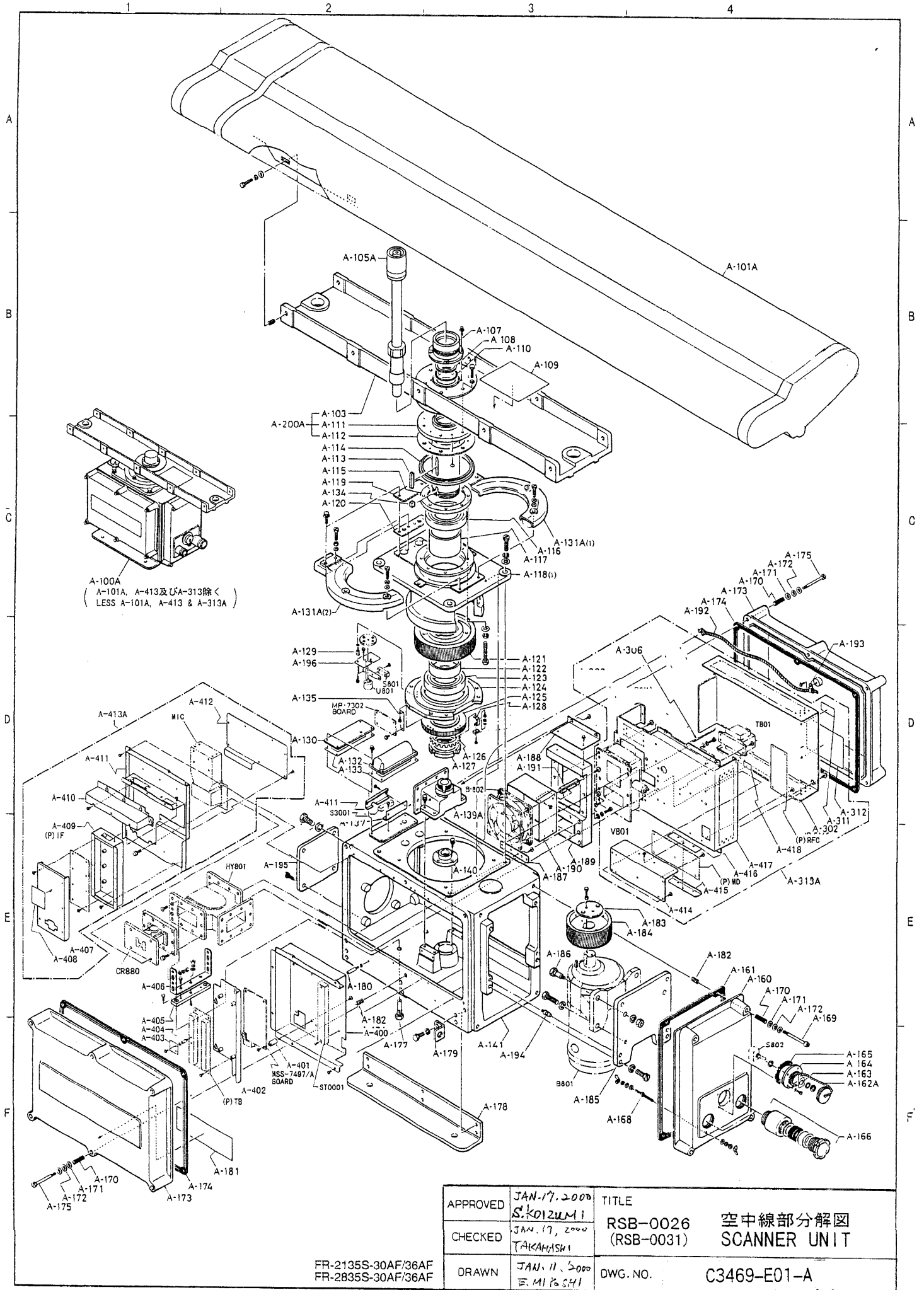

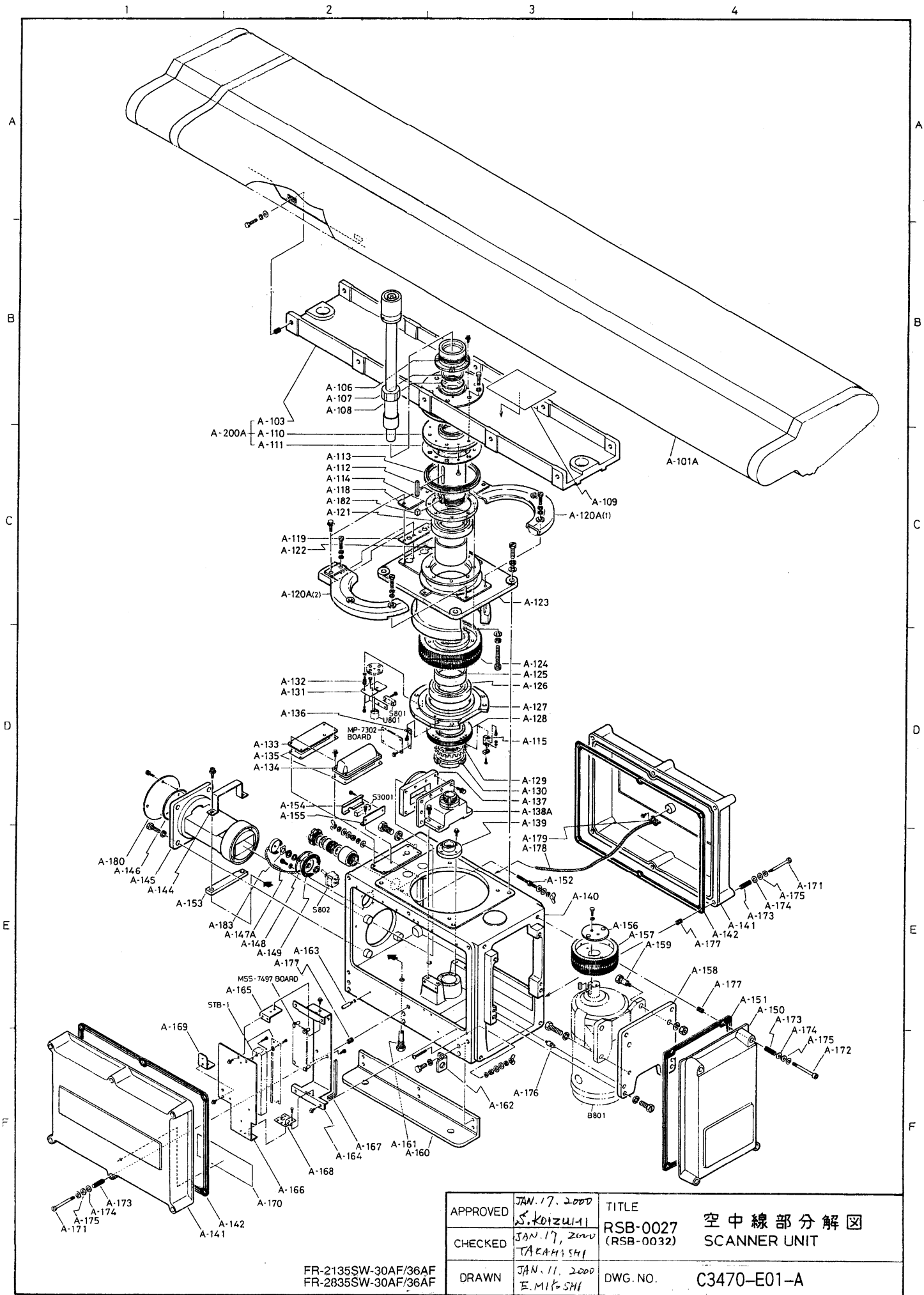

FR-2135SW-30AF/36AF  
FR-2835SW-30AF/36AF

APPROVED	JAN. 17. 2000 S. KOIZUMI	TITLE	空中線部分解図 SCANNER UNIT
CHECKED	JAN. 17. 2000 TAKAHASHI	RSB-0027 (RSB-0032)	
DRAWN	JAN. 11. 2000 E. MIYASHI	DWG. NO.	C3470-E01-A





**FURUNO**

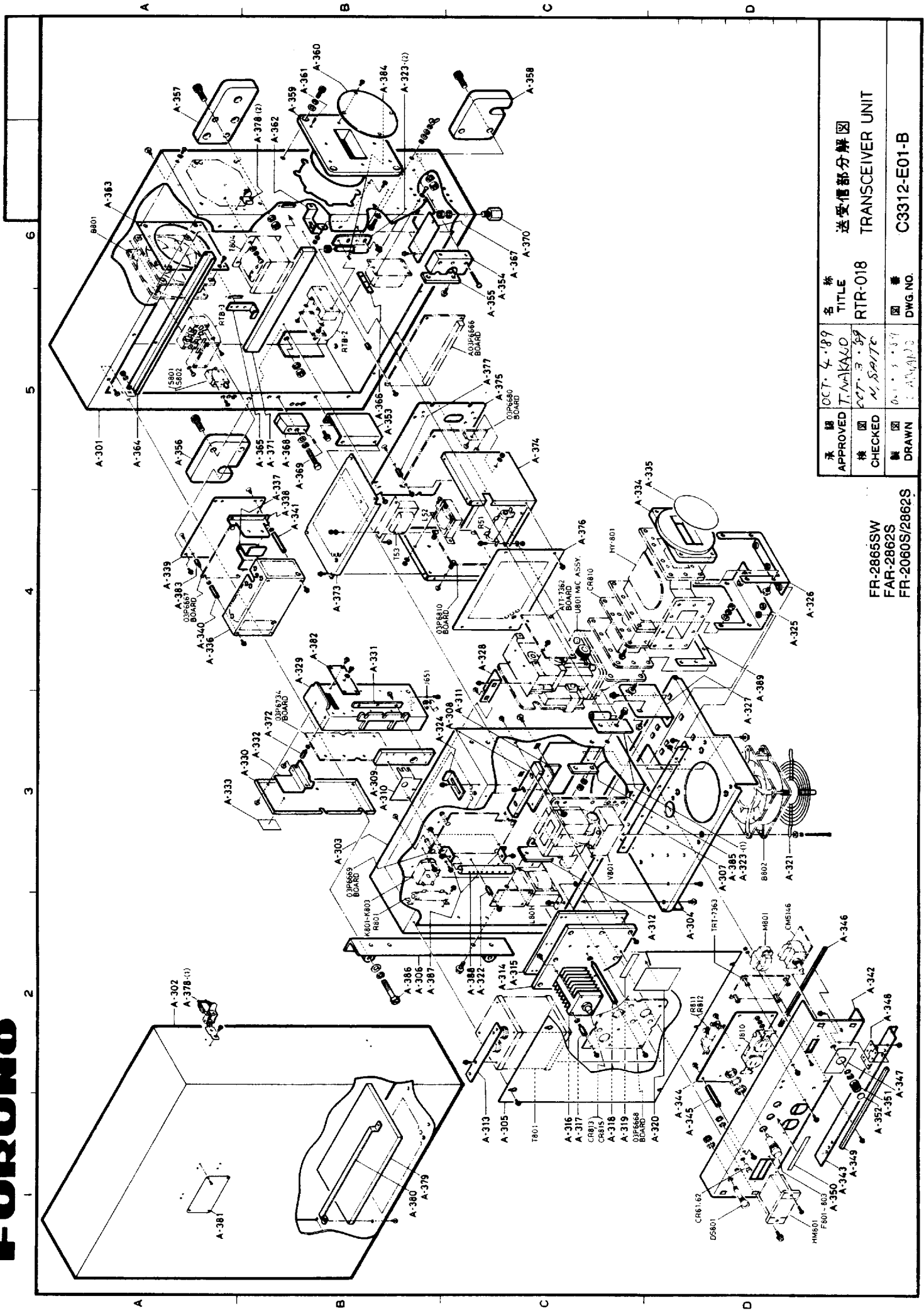

承認 APPROVED	名 称 TITLE	送受信部分分解図 TRANSCIVER UNIT
検 査 CHECKED	RTR-018	
製 図 DRAWN	図 番 DWG. NO.	C3312-E01-B

FR-2865SW  
 FAR-2862S  
 FR-2060S/2862S

FURUNO ELECTRIC CO., LTD.

# FURUNO®

**FURUNO ELECTRIC CO., LTD.**

9-52 Ashihara-Cho, Nishinomiya City, 662-8580, Hyogo, Japan

Tel: +81 798-65-2111 Fax: +81 798-65-4200

Pub NO. DOC-259

## Declaration of conformity to type

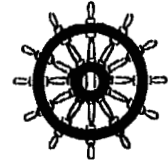

We **FURUNO ELECTRIC CO., LTD.**

(Manufacturer)

9-52 Ashihara-Cho, Nishinomiya City, 662-8580, Hyogo, Japan

(Address)

hereby declare under our sole responsibility that the product

Shipborne radar models FR-28X5 and shipborne radar/ARPA models FAR-28X5 series  
(for details, see Configuration matrix at page 2/2 of this Declaration)

(Model names, type numbers)

to which this declaration relates conforms to the following standard(s) or normative document(s)

IMO Performance Standard

IMO Resolution A.477 (XII)  
IMO Resolution A.694 (17)  
IMO Resolution A.813 (19)  
IMO Resolution MSC.64(67) Annex 4  
IMO Resolution A.422 (XI)  
IMO Resolution A.823 (19)

IEC Test standard

IEC 60936  
IEC 60945  
IEC 61162-1  
IEC 60872  
IEC 60872-1

(title and/or number and date of issue of the standard(s) or other normative document(s))

For assessment, see EC – type approval certificate no. 6522/1058/1999 of 17 December 1999 issued by Federal Maritime and Hydrographic Agency, the Federal Republic of Germany

This declaration is issued according to the provisions of European Council Directive 96/98/EC on marine equipment modified by Commission Directive 98/85/EC.

On behalf of Furuno Electric Co., Ltd.

Hiroaki Komatsu  
Manager,  
International Rules and Regulations

Nishinomiya City, Japan  
January 6, 2000

(Place and date of issue)

(name and signature or equivalent marking of authorized person)

**Configuration matrix of FR/FAR-28X5 series**  
(This is part of Declaration of conformity to type DOC-259)

Designation		Model										
		FR-2815	FR-2825	FR-2825W	FR-2835S	FR-2835SW	FAR-2815	FAR-2825	FAR-2825W	FAR-2835S	FAR-2835SW	
Scanner	XN20AF	x	x	x			x	x	x			6.5 ft, X-band
	XN24AF	x	x	x			x	x	x			8 ft, X-band
	SN7AF				x	x				x	x	12 ft, S-band
Transceiver	RTR-062	x					x					12 kW, X-band, TR-up
	RTR-063		x					x				25 kW, X-band, TR-up
	RTR-046			x					x			25 kW, X-band, TR-down
	RTR-066				x					x		30 kW, S-band, TR-up
	RTR-047					x					x	30 kW, S-band, TR-down
Turning unit	RSB-0074	x	x				x	x				24 VDC, 24 rpm
	RSB-0032					x					x	380/440 VAC, 3 ø, 400 W
	RSB-0026				x					x		200/230 VAC, 3 ø, 400 W
	RSB-0031				x					x		380/440 VAC, 3 ø, 400 W
	RSB-0027					x					x	200/230 VAC, 3 ø, 400 W
	RSB-0076			x						x		200/230 VAC, 3 ø, 150 W
	RSB-0077			x						x		380/440 VAC, 3 ø, 150 W
Display unit	RDP-115	x	x	x	x	x						Radar display unit
	RDP-115A						x	x	x	x	x	Radar/ARPA display unit
Ancillary equipment	AD-100	x	x	x	x	x	x	x	x	x	x	either one of AD-100 (Gyro converter) or GC-8 (Gyro interface)
	GC-8	x	x	x	x	x	x	x	x	x	x	
	PM-30	x	x	x			x	x	x			Performance monitor, X-band
	PM-50				x	x				x	x	Performance monitor, S-band
	PSU-004			x	x	x				x	x	Power supply unit
	RJ-7	x	x	x	x	x	x	x	x	x	x	Interswitch

# FURUNO®

**FURUNO ELECTRIC CO., LTD.**

9-52 Ashihara-Cho, Nishinomiya City, 662-8580, Hyogo, Japan

Tel: +81 798-65-2111 Fax: +81 798-65-4200

Pub NO. DOC-406

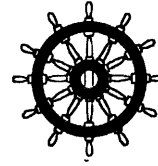
**Declaration of conformity****0735**We **FURUNO ELECTRIC CO., LTD.**

(Manufacturer)

9-52 Ashihara-Cho, Nishinomiya City, 662-8580, Hyogo, Japan

(Address)

hereby declare under our sole responsibility that the product

Shipborne radar and ARPA models FAR/FR-28X5  
(for details, see Configuration matrix at page 2/2 of this Declaration)

(Model names, type numbers)

to which this declaration relates conforms to the following standard(s) or normative document(s)

<u>Standard</u>	<u>Test standard</u>
IMO Resolution A.477 (XII)	IEC 60936
IMO Resolution A.694 (17)	IEC 60945
IMO Resolution A.813 (19)	IEC 61162-1
IMO Resolution MSC.64(67) Annex 4	IEC 60936-1
IMO Resolution A.422 (XI)	IEC 60872
IMO Resolution A.823 (19)	IEC 60872-1
IMO Resolution MSC.64(67) Annex 4, Appendix 2	IEC 60872-3

(title and/or number and date of issue of the standard(s) or other normative document(s))

For assessment, see EC – type approval certificate no. 6522/1058/1999 of 17 December 1999 and its annexes No. 1 of 30 March 2001 and No.2 of 30 November 2001 issued by Federal Maritime and Hydrographic Agency, the Federal Republic of Germany

This declaration is issued according to the provisions of European Council Directive 96/98/EC on marine equipment modified by Commission Directive 98/85/EC.

On behalf of Furuno Electric Co., Ltd.

Hiroaki Komatsu  
Manager,  
International Rules and Regulations

Nishinomiya City, Japan  
January 21, 2002

(Place and date of issue)

(name and signature or equivalent marking of authorized person)

**Configuration matrix of FAR-28X5 Series**  
(This is part of the Declaration of Conformity DOC-406)

Designation	Model	FR-2815	FR-2825	FR-2825W	FAR-2815	FAR-2825	FAR-2825W	FR-2835S	FR-2835SW	FAR-2835S	FAR-2835SW	Remarks
Scanner	XN20AF	x	x	x	x	x	x					6.5 Ft, X-band
	XN24AF	x	x	x	x	x	x					8 ft, X-band
	SN7AF							x	x	x	x	12 ft, S-band
	SN36AF							x	x	x	x	12 ft, S-band
Transceiver	RTR-062	x			x							12 kW, X-band, TR-up
	RTR-063		x			x						25 kW, X-band, TR-up
	RTR-046			x			x					25 kW, X-band, TR-down
	RTR-066							x		x		30 kW, S-band, TR-up
	RTR-047								x		x	30 kW, S-band, TR-down
Turning unit	RSB-0074	x	x		x	x						24 VDC, 24 rpm
	RSB-0032								x		x	380/440 VAC, 3 $\phi$ , 400 W
	RSB-0026							x		x		220/230 VAC, 3 $\phi$ , 400 W
	RSB-0031							x		x		380/440 VAC, 3 $\phi$ , 400 W
	RSB-0027								x		x	220/230 VAC, 3 $\phi$ , 400 W
	RSB-0076			x			x					220/230 VAC, 3 $\phi$ , 150 W
	RSB-0077			x			x					380/440 VAC, 3 $\phi$ , 4150 W
Display unit	RDP-115	x	x	x				x	x			Display unit
	RDP-115A				x	x	x			x	x	
Other mandatory equipment	AD-100/GC-8	x	x	x	x	x	x	x	x	x	x	Either one of AD-100 (Gyro converter) or GC-8 (Gyro interface)
	PM-30	x	x	x	x	x	x					Performance monitor, X-band
	PM-50							x	x	x	x	Performance monitor, S-band
	PSU-004			x			x	x	x	x	x	Power supply unit
	IF-2300	x	x	x	x	x	x	x	x	x	x	Interface unit
Optional equipment	RJ-7	x	x	x	x	x	x	x	x	x	x	Interswitch unit

**FURUNO****FURUNO ELECTRIC CO., LTD.**

9-52 Ashihara-Cho, Nishinomiya City, 662-8580, Hyogo, Japan

Tel: +81 798-65-2111 Fax: +81 798-65-4200

Pub NO. DOC-308

**Declaration of Conformity**We **FURUNO ELECTRIC CO., LTD.**-----  
(Manufacturer)

9-52 Ashihara-Cho, Nishinomiya City, 662-8580, Hyogo, Japan

-----  
(Address)

declare under our sole responsibility that the product

X-band radar and ARPA Models FR-2855 and FAR-2855 together with Power supply unit PSU-001 and PSU-004, and Video plotter RP-25 for navigation  
(Serial No. 3317-0015 and 3328-0016)-----  
(Model name, serial number)

are in conformity with the essential requirements as described in the Directive 1999/5/EC of the European Parliament and of the Council on radio equipment and telecommunications terminal equipment (R&amp;TTE Directive) and satisfies all the technical regulations applicable to the product within this Directive

EN 60945: 1997-01 (IEC 60945 Third edition: 1996-11)

ITU R.R. App. S3 Table 2, Edition 1998

-----  
(title and/or number and date of issue of the standard(s) or other normative document(s))

For assessment, see

- Statement of Opinion N° 00214125/AA/00 of 2 January 2001 issued by KTL Certification, The Netherlands
- Test reports 96312400 of 31 July 1996 and 95326200 of 25 March 1996 prepared by Telefication, The Netherlands and TI-1579 of 20 June 1996 prepared by Furuno Electric Co., Ltd.

On behalf of Furuno Electric Co., Ltd.

Hiroaki Komatsu  
Manager,  
International Rules and RegulationsNishinomiya City, Japan  
January 15, 2001-----  
(Place and date of issue)-----  
(name and signature or equivalent marking of authorized person)

**FURUNO****FURUNO ELECTRIC CO., LTD.**

9-52 Ashihara-Cho, Nishinomiya City, 662-8580, Hyogo, Japan

Tel: +81 798-65-2111 Fax: +81 798-65-4200

Pub NO. DOC-309

**Declaration of Conformity**We **FURUNO ELECTRIC CO., LTD.**-----  
(Manufacturer)

9-52 Ashihara-Cho, Nishinomiya City, 662-8580, Hyogo, Japan

-----  
(Address)

declare under our sole responsibility that the product

X-band radar and ARPA Models FR-2855W and FAR-2855W together with Power supply unit PSU-004 and Video plotter RP-25 for navigation  
(Serial No. 3317-0015 and 3328-0016)

-----  
(Model name, serial number)

are in conformity with the essential requirements as described in the Directive 1999/5/EC of the European Parliament and of the Council on radio equipment and telecommunications terminal equipment (R&TTE Directive) and satisfies all the technical regulations applicable to the product within this Directive

EN 60945: 1997-01 (IEC 60945 Third edition: 1996-11)

ITU R.R. App. S3 Table 2, Edition 1998

-----  
(title and/or number and date of issue of the standard(s) or other normative document(s))

For assessment, see

- Statement of Opinion N° 00214126/AA/00 of 3 January 2001 issued by KTL Certification, The Netherlands
- Test reports 96312400 of 31 July 1996 and 95326200 of 25 March 1996 prepared by Telefication, The Netherlands and TI-1655 of 1 October 1997 prepared by Furuno Electric Co., Ltd.

On behalf of Furuno Electric Co., Ltd.

Hiroaki Komatsu

Manager,

International Rules and Regulations

Nishinomiya City, Japan  
January 15, 2001-----  
(Place and date of issue)-----  
(name and signature or equivalent marking of authorized person)



**FURUNO****FURUNO ELECTRIC CO., LTD.**

9-52 Ashihara-Cho, Nishinomiya City, 662-8580, Hyogo, Japan

Tel: +81 798-65-2111 Fax: +81 798-65-4200

Pub NO. DOC-310

**Declaration of Conformity**We **FURUNO ELECTRIC CO., LTD.**-----  
(Manufacturer)

9-52 Ashihara-Cho, Nishinomiya City, 662-8580, Hyogo, Japan

-----  
(Address)

declare under our sole responsibility that the product

S-band radar and ARPA Models FR-2865SW and FAR-2865SW together with Power  
supply unit PSU-004 and Video plotter RP-25 for navigation  
(Serial No. 3328-0016)-----  
(Model name, serial number)are in conformity with the essential requirements as described in the Directive  
1999/5/EC of the European Parliament and of the Council on radio equipment and  
telecommunications terminal equipment (R&TTE Directive) and satisfies all the  
technical regulations applicable to the product within this DirectiveEN 60945: 1997-01 (IEC 60945 Third edition: 1996-11)  
ITU R.R. App. S3 Table 2, Edition 1998-----  
(title and/or number and date of issue of the standard(s) or other normative document(s))

For assessment, see

- Statement of Opinion N° 00214127/AA/00 of 3 January 2001 issued by KTL Certification, The Netherlands
- Test reports 96312200 of 31 July 1996 prepared by Telefication, The Netherlands and TI-1639 of 2 April 1997 prepared by Furuno Electric Co., Ltd.

On behalf of Furuno Electric Co., Ltd.

Hiroaki Komatsu  
Manager,  
International Rules and RegulationsNishinomiya City, Japan  
January 15, 2001-----  
(Place and date of issue)-----  
(name and signature or equivalent marking of  
authorized person)